

American University in Cairo

## AUC Knowledge Fountain

---

Theses and Dissertations

---

2-1-2018

### Economic benefits of surface runoff harvesting for supplemental irrigation for sub-saharan Africa: Case study of Soroti, Uganda

Fahad Kimera

Follow this and additional works at: <https://fount.aucegypt.edu/etds>

---

#### Recommended Citation

##### APA Citation

Kimera, F. (2018). *Economic benefits of surface runoff harvesting for supplemental irrigation for sub-saharan Africa: Case study of Soroti, Uganda* [Master's thesis, the American University in Cairo]. AUC Knowledge Fountain.

<https://fount.aucegypt.edu/etds/473>

##### MLA Citation

Kimera, Fahad. *Economic benefits of surface runoff harvesting for supplemental irrigation for sub-saharan Africa: Case study of Soroti, Uganda*. 2018. American University in Cairo, Master's thesis. *AUC Knowledge Fountain*.

<https://fount.aucegypt.edu/etds/473>

This Thesis is brought to you for free and open access by AUC Knowledge Fountain. It has been accepted for inclusion in Theses and Dissertations by an authorized administrator of AUC Knowledge Fountain. For more information, please contact [mark.muehlhaeusler@aucegypt.edu](mailto:mark.muehlhaeusler@aucegypt.edu).



Centre for Sustainable Development Program

**Economic Benefits of Surface Runoff Harvesting for Supplemental irrigation for**

**Sub-Saharan Africa: Case Study of Soroti, Uganda**

Submitted by

**Fahad Kimera**

A Thesis Submitted to Graduate Program in Sustainable Development

In partial fulfilment of the requirements for the

Degree of Master of Science In

Sustainable Development

Under the supervision of:

**Prof. Dr. Hani Sewilam** (Advisor)

Professor, Mechanical Engineering Department

& Director, Center of Sustainable Development,

School of Science and Engineering

**Dr. Emad Imam | PhD** (Co-Advisor)

Professor of Hydraulics and Water Resources

Department of Construction Engineering

The American University in Cairo

## Abstract

Fresh water is a finite and a vulnerable resource that sustains life, development, and the environment. Approximately 80% of the world's cultivable land depends on rainfall, interestingly rain-fed production produces up to 70% of the global food supply yet it's the same system that has been threatened with frequent dry spells and long term droughts. Estimates show that uncertain weather conditions and insufficient water for irrigation could lead agricultural productivity in several countries to fall by up to 50% over the next decade, severely affecting their prospects of greater social and economic development. Rainwater harvesting is the collection and storage of any farm water either runoff or creek flow for irrigation use. Rainwater harvesting for supplemental irrigation is currently the best practice to mitigate the escalating issue of water shortage caused by concurrent agricultural droughts. One form of mitigating the negative effects of such droughts and dry spells is the establishment of small scale simple low cost supplemental irrigation schemes in rain-fed agriculture. This is to reduce the extent of crop failures and as well increase the water use efficiency WUE of crops. In a developing country like Uganda where more than 80% of the population lives in rural areas and their lives depends on rain-fed agriculture. Droughts and dry spells have greater consequences to the peoples' survival and development. This study presents a sustainable economic solution for the problem of crop yield reduction due to short droughts during the rainy season, more particularly for maize as a staple crop. It aims at reducing maize crop failures by supplying supplemental irrigation during the critical growth stages of the plant. It employs FAO's water productivity model (Aquacrop) to estimate and predict the potential economic benefits of supplemental irrigation as well as the cost benefit analysis to examine the optimization of the supplemental system. Results show that applying supplemental irrigation in case of low soil moisture during the critical stages of maize can have greater crop yield increments. Optimization of the system is achieved when a farmer sacrifices about 5% of his hectare piece of land to establish a runoff lined storage pond of 800 cubic meters by volume along with a diesel pump for water lifting using furrow irrigation. Using such volume of PVC lined pond covered with a natural mat of growing Azolla plant on the water surface can give optimum yields on a one hectare crop land. Azolla, the aquatic floating fern has multi benefits, however, its primary importance in this study is keeping the water pond environmentally safety. The proposed supplemental irrigation scheme has a payback period of 6 years.

## Acknowledgement

First I would like to thank the Center for Sustainable Development at the American University in Cairo (AUC) for giving me the outstanding opportunity to pursue my Masters of Science in Sustainable Development. I would also like to thank the African Graduate Fellowship Program at AUC for sponsoring my studies. I am especially grateful to Prof. Dr Adham Ramadan and Mrs. Sawsan Mardini for making this opportunity a reality.

I am also grateful and thankful to Prof. Dr. Hani Sewilam the Director and Professor at the Center for Sustainable Development Program at AUC and main Advisor for my thesis, for his endless support and professional advice from the beginning till the end of the whole research period. Additionally I would like to thank Mr. Mohamed Khaled – the Secretary and coordinator for Sustainable Development Program for his generous support.

Furthermore I would also like to express my sincere gratitude to Prof. Dr. Emad Imam, the Professor of Hydraulics and Water Resources and second Advisor for this thesis, for his continuous guiding and advising during the whole research process. I want also to thank my examiners Prof. Dr. Hoda Soussa and Prof. Dr. Ahmed El-Gendy for their valuable remarks for my work.

I would like to thank everyone who helped me in the process of data collection and field visits. These include but not limited to: The Nile Basin Initiative in Uganda for providing me with professional support and relevant data, The Uganda National Meteorological center in Kampala for providing the climatic data, Busitema University Moslem Students Association in Arapai campus for their support while in the field, Mr. Moses Ojara - a soil analyst, Soroti Farmers groups that supported me during the field visits and Mr. Godfrey Ofwono for his technical and constructional services that made this project a reality.

Special thanks to my colleagues and friends who supported me in my research: Mr. Kareem Saleh – MBA, Chimsom Chikumeka, Eric Zadok, Mugwanya Muziri, Kegere James, Sendaaza Charles, Ogwang Joel, Nambafu Doreen, and all my classmates in the Sustainable Development class Fall 2015.

I would like to have my deepest thanks to my parents – Mr. Musa Ssuna and Mrs. Rukiyah Ssuna, my brothers and sisters for their support and encouragement throughout the whole studies. Special thanks go to my wife Laila Musa Kimera and son Jasim Malik Kimera for their patience and Motivation throughout the whole research process. Lastly I would like to send my heartfelt prayers to the mother of my son Aisha Nabiddo who passed away during the course of the research process, May the Almighty God have mercy on her soul.

## Table of Contents

<b>Abstract</b> .....	<b>i</b>
<b>Acknowledgement</b> .....	<b>i</b>
<b>Table of Contents</b> .....	<b>ii</b>
<b>List of Figures</b> .....	<b>v</b>
<b>List of Tables</b> .....	<b>vi</b>
<b>Chapter 1. Introduction</b> .....	<b>1</b>
1.1: Problem Statement .....	2
1.2: Research Goal, Aim and Objective .....	4
1.3: Research Questions .....	5
1.4: Research Approach.....	5
<b>Chapter 2. Background and Literature Review</b> .....	<b>7</b>
2.1: Terminologies .....	7
2.2: Rainwater harvesting (RWH) .....	10
2.2:1: Major forms of Rainwater Harvesting (RWH) .....	12
2.3: Concept for Runoff Harvesting.....	13
2.4: Water harvesting systems and techniques .....	14
2.4:1: Water collection systems .....	14
2.4:2: Water Storage systems .....	15
2.5: Rainwater harvesting and management (RWHM) .....	16
2.5:1: Micro-catchment systems.....	16
2.5:2: Macro-catchment systems.....	18
<b>Chapter 3. Water shortage Mitigation Scheme</b> .....	<b>23</b>
3.1: Common Water Harvesting Techniques in Uganda .....	23
3.1:1: Plastic and concrete water storage medium .....	24
3.1:2: Earthen Pond water storage .....	24
3.1:3: Pros and Cons of an excavated water pond.....	25
3.1:4: Different types of Earthen water ponds .....	25
3.2: Supplemental Irrigation (SI) .....	27
3.2:1: Schedule of supplemental irrigation .....	28
3.3: Feasibility of Supplemental runoff irrigation in macro-systems .....	29
3.4: Overview of Cost Benefit Analysis.....	30

<b>Chapter 4. Study Area – Soroti.....</b>	<b>33</b>
4.1: The physical environment of the study Area .....	33
4.2: Topography and Climate of Soroti District in Uganda.....	35
4.3: Rainfall patterns, distribution and seasons.....	35
4.4: Land Use in the study Area.....	37
4.4:1: Crop Production .....	37
4.4:2: Maize production .....	37
4.4:3: Maize water Requirements.....	39
4.4:4: Charcoal Burning .....	41
4.5: Soils and topographical surveys of selected areas in Soroti district .....	41
4.6: Profile soil sampling and laboratory soil results.....	42
4.6:1: Soil Physical Characteristics .....	43
4.6:2: Laboratory Analysis .....	44
4.7: Effective Rooting Depth .....	44
4.8: Elevations, slopes and Soil Erosion Harvard.....	45
4.9: Irrigation Practice .....	45
4.10: Proposed Supplemental Irrigation system .....	47
4.11: Advantages and Limitations for using Pond liners .....	50
4.12: Using Azolla .....	51
4.13: Ways of Water uplifting from the Pond .....	53
4.14: Costs related to the development of the Supplemental Irrigation Scheme .....	56
4.14:1: Capital Costs.....	56
<b>Chapter 5. Simulation Water Model .....</b>	<b>60</b>
5.1: Description of Aquacrop - Crop water Model .....	60
5.2: Aquacrop Model Framework .....	61
5.3: Model Applications.....	61
5.4: Simulation of Soil water Balance.....	63
5.4:1: Water stress related to yield formation.....	64
5.4:2: Water stress effect on flowering.....	65
5.5: Modeling for Irrigation Management .....	66
5.6: Crop characteristics.....	67
5.7: The climatic parameters.....	69
5.8: Model Results.....	70

5.8:1: Rain-fed Production Analysis .....	70
5.8:2: Net irrigation water needs for Maize .....	72
5.8:3: Reducing the Maize water gap.....	73
5.8:4: Optimization of the pond size/volume .....	74
5.8:5: Temperature and Rainfall variability.....	77
5.9: Discussion of Model Results .....	77
5.9:1: 10 years Rain-fed analysis .....	77
5.9:2: Net Irrigation water needs .....	78
5.9:3: Reducing the maize water gap.....	79
5.9:4: Optimization of the pond size/volume .....	79
5.9:5: Temperature and Rainfall variability.....	81
5.10: Cost Benefit Analysis results and Discussion.....	81
5.10:1: Monetary Yields for Different pond volumes for 10 years in UGX (Historical) .....	81
5.10:2: Average Growth YOY (Forecast).....	84
5.10:3: Net present Value (NPV) .....	85
5.10:4: Optimization of Supplemental Irrigation .....	86
<b>Chapter 6. Conclusions and Recommendations .....</b>	<b>88</b>
<b>Works Cited .....</b>	<b>92</b>
<b>Appendix.....</b>	<b>99</b>

## List of Figures

Figure 1.1 Dried maize plantation due to drought (Mugasha, 2014).....	3
Figure 2.1 Rainfall Partitioning into flow components in Rain fed Agricultural Areas .....	12
Figure 2.2 The Basic Principle of Rainwater harvesting for Agriculture .....	13
Figure 2.3 Different water Harvsting techniques classified according to their water source and the storage time span. (Fox, 2001).....	15
Figure 2.4 Typical designation of the micro-catchment rainwater harvesting systems.....	16
Figure 2.5 A typical designation of the macro-catchment rainwater harvesting systems. ....	19
Figure 3.1 Different water harvesting technologies (FAO T. , 2012).....	24
Figure 3.2 Excavated water Pans.....	26
Figure 3.3 Different Water harvesting ponds.....	27
Figure 3.4 Cost Benefit Framework.....	31
Figure 4.1 Map showing Soroti - the study area in Eastern Uganda.....	33
Figure 4.2 Uganda Cattle Corridor (Dark grey area stretching from South west to north east). (Steece, 2011).....	34
Figure 4.3 Uganda mean annual rainfall in main drainage sub-basins. (Nsubuga, Namutebi, & Ssenfuma, 2014) .....	36
Figure 4.4 Uganda's growing Seasons (FAO, Global Yield Gap Atlas, 2013) .....	38
Figure 4.5 Farmers hand weeding a maize plantation .....	39
Figure 4.6 Maize growth stages (PANNAR, 2016).....	40
Figure 4.7 Deforestation for Charcoal burning .....	41
Figure 4.8 shows the soils types in Soroti district under FAO classification .....	42
Figure 4.9 Soil sampling in the study area .....	43
Figure 4.10 Soil pit for soil sampling .....	45
Figure 4.11 Supplemental Irrigation System adopted and modified from Pandey (2013) .....	49
Figure 4.12 Runoff harvesting pond under construction in the study area.....	50
Figure 4.13 The enormous benefits of Azolla.....	52
Figure 4.14 Azolla mat on a water surface for animal feeds .....	52
Figure 4.15 Rope and Bucket system (Shiksha, 2017).....	54
Figure 4.16 Operation of a Treadle pump .....	55
Figure 5.1 Shows the framework of the aquacrop model adopted from (FAO, Aquacrop, 2016).....	61
Figure 5.2 Shows crop physiological Concept (Vanuytrecht, et al., 2014).....	63
Figure 5.3 Soil Water Balance (FAO, Aquacrop, 2016) .....	64
Figure 5.4 Effect of water stress on harvests (FAO, Aquacrop, 2016).....	65
Figure 5.5 the Maize Growth cycle (FAO, Aquacrop, 2016) .....	67
Figure 5.6 Effective Rooting depth and Maximum Maize CC reference (FAO, Aquacrop, 2016).....	69
Figure 5.7 Net Irrigation water needs and Potential Cumulative Annual runoff (Irrigation Demand Vs Supply).....	73
Figure 5.8 Irrigation water gap.....	74
Figure 5.9 Yield (ton/ha) for Supplemental Furrow Irrigation .....	75
Figure 5.10 Yield (ton/ha) for Supplemental Drip Irrigation .....	76
Figure 5.11 Furrow and Drip irrigation.....	77
Figure 5.12 Regression Analysis.....	77
Figure 5.13 Profitability of different pond sizes with different lifting techniques .....	87



## List of Tables

Table 2.1 Micro-catchment rainwater harvesting in sub-Saharan Africa (Biazin , Sterk, & Temes, 2012).....	17
Table 2.2 Macro-catchment rainwater harvesting (Biazin , Sterk, & Temes, 2012).....	20
Table 4.1 Summary of the site characteristics of the studied soil.....	44
Table 4.2 Pond Dimensions and Construction costs.....	57
Table 4.3 Summarized Costs for the water lifting Techniques for supplemental Irrigation .....	59
Table 5.1 A decade Analysis of Rain-fed Agriculture for the growing season (March – June)..	71
Table 5.2 Historical Seasonal Monetary yields .....	82
Table 5.3 Monetary Yield Value (Forecast).....	84
Table 0.1 Net Present Values for the projected 17 years for different pond volumes .....	99
Table 0.2 NPV for the different water lifting techniques .....	101

## Chapter 1. Introduction

Water is an essential element in socio-economic and environmental development (UNWater/FAO, 2007). Shortage of this finite resource has mega negative consequences to the lives of the people. It poses crucial challenges on a global scale. Indeed dealing with water related issues like irrigation, hydropower and watershed management is a very influential and sensitive matter in line with sustainable development and global stability. It was reported by Rockstrom, et al. (2009) that in the middle of the 21<sup>st</sup> century, more than half of the global population will have limited access to water. Different researchers have reported the need to reduce and minimize water usage. Regardless of the economic progress made by some countries in the developing world, almost all of the African countries still lag behind compared to rest of the world in terms of water accessibility, management, consumption and supply.

On a global scale, water has become an increasingly scarce resource, and in sub-Saharan Africa, it's a potential threat to the regional security and development. Currently the African Continent is facing vast challenges and amongst them is extreme poverty, diseases, population explosion and at a greater extent the variability in climatic patterns. (Falkenmark & Rockström, 2006), (Pandey, Zaag, & Soupir, 2013) reported that by 2050, the world will need an additional 5,000km<sup>3</sup>/year of water for sustenance and also to meet the increasing food demands brought about by the booming population. So many researchers around the globe have suggested on the fact that supplemental irrigation to rain-fed agricultural settings could be a potential solution to the increasing food demands (Rockström, Barron, & Fox, 2003) (Rockstrom, 1997).

Food and Agriculture Organization (FAO) reported that almost three quarters of the fresh water resources in sub-Saharan Africa are used for agricultural purposes. Estimates show that uncertain weather conditions as well as insufficient water for irrigation could lead agricultural productivity in several countries to fall by up to 50% over the next decade, severely affecting their prospects of greater social and economic development (Freitas, 2013). Without water everything gets stagnant, peoples' lives are constrained, productivity slows down and most importantly water shortage leads to disease break-outs, poverty, extreme hunger and vulnerability. In 2006, the Human Development Report documented that "1.1 billion people in the developing nations had no access to water..." (UNDP, 2006). Making matters worse, almost all rural population in developing countries depend on agriculture for their food and income; their lives have already been threatened due to the shortage in water for agricultural production.

Indications from a study report conducted by the International Food Policy Research Institute (IFPRI) showed that by the year 2020, developing nations most especially in Asia and Africa will have an

estimated food demand of about 400 million tons of food to be able to feed their entire population. This will be the deficit amounts of food required above the total annual food production plus imports to cater for the food demands of region's inhabitants. Poverty plus hunger are so far the biggest challenges faced by the two regions, this is so due to the fact that a big proportion of agricultural land is subjected to recurrent dry spells and affected with water scarcity.

Statistics have shown that 65% of sub-Saharan population resides in rural areas and these are the same people who rely on rain-fed agriculture (Worldbank, 2000). Almost 94% of agricultural land south of the Sahara desert depends on rainfall for crop production (Pandey, Zaag, & Soupir, 2013). For instance all the 11 Nile Basin countries are considered underdeveloped and poor amongst other African countries. Actually half of them are amongst the 10 poorest nations in the whole world (Yohannes & Yohannes, 2012). In a bid to rectify the alarming poverty crisis in these regions, rapid industrialization, education and investments in irrigation based agriculture should be priorities.

Agriculture, a main contributor to Uganda's economy made up almost a quarter of the gross domestic product (GDP) in 2013 (NPA, 2015). The sector's pivotal role is further shown in the fact that it employs more than half of the country's population in addition to providing a foundation for the development of other economic spheres such as services provision and manufacturing. In its second series, the Ugandan national development plan aims to focus on a total of 12 agricultural initiatives, including maize production. Among others, emphasis will be placed on supporting agricultural research, adaptation of on-farm technologies and construction of water schemes for irrigation and livestock (NPA, 2015).

## 1.1: Problem Statement

Water shortage for irrigation is one of the main problems hindering agricultural production and development in Africa in general and Uganda in particular. Lack of enough water to supplement rain-fed agriculture in the region directly affects the region's food security and can trigger disastrous calamities like famine, diseases, drought and massive death. Sub-Saharan Africa for ages has been depending on rain-fed agriculture since the past centuries and it proved efficient and dependable until the effects of climate change twisted and changed the natural environmental conditions.

A study conducted by Falkenmark, et al. (2001) reported that an approximate 80% of the world's cultivable land depends on rainfall and this rain-fed production produces up to 70% of the global food supply. However it's the same system that has been threatened with frequent dry spells and long droughts. There is a significant change in rainfall patterns, intensities and distribution which is at a larger extent due to the effect of climate change in addition to deforestation and the poor farming practices (Falkenmark, Fox, Persson, & Rockstrom, 2001).

Food and Agricultural Organization (FAO) reported that in Sub-Saharan Africa, there is an approximate 42 Million hectares of land that require irrigation. However rainfall does not provide the required soil moisture to support full production of crops (FAO, Irrigation in Africa in Figures, 1995). Historically there has been no substantial irrigation practices south of the Sahara desert over so many years. This has been partly because of the high investment costs of irrigation schemes and its related management costs and also due to the fact that Sub-Saharan Africa was naturally gifted with abundant resources like rainfall, fertile lands and enough human labor to work on farm lands.

Moisture stress to crops in Uganda has become the biggest challenge in the agricultural industry. So many parts of the country have experienced the wrath of climatic effects. Ronald Kalali (Mugasha, 2014) an agricultural officer at Mobuku government prison, Western region of the country narrated how drought drove their 300 acres of land to zero yields. “We were going to utilize all the rains because we planted in time but unfortunately we stopped receiving rains in March immediately after we had planted. We are expecting zero yields,” **Figure 1.1** shows part of the 300 acres of a failed maize plantation due to drought at the flowering stage.

#### **A failed maize plantation due to drought in Uganda**



**Figure 1.1 Dried maize plantation due to drought (Mugasha, 2014)**

Different authors have cited that the effects of climate change are believed to have caused this un-uniform distribution of rainfall even within the rainy seasons. The maize crop requires an average amount of water of about 500-800mm of water per season depending on several factors. In 2007, the Intergovernmental Panel on Climate Change (IPCC) projected that in 2020, rain-fed agricultural crop yields in Sub-Saharan Africa will reduce by 50% due to the effects of climatic change (Mubiru, 2010).

In their report, IPCC emphasized the benefit of supplemental irrigation mostly if applied during the dry spell periods that occasionally appear during the planting season (Mubiru, 2010).

There are quite various techniques that can be applied to avail water for irrigation in rain-fed agricultural system depending on the geographical location, soil type, rainfall patterns, crops under cultivation and frequency of drought occurrence. Water can be accessed through rainwater harvesting, pumping or diversion of water from a near-by stream into irrigation distribution channels, pumping from underground wells, etc.

## 1.2: Research Goal, Aim and Objective

**Goal** - The intended goal of this research is to increase the maize productivity through reducing crop failures during the moisture-critical growth stages. To a greater extent, these failures are due to low moisture content in the soil along the crop growth cycle in Rain-fed agricultural systems.

**Aim** – The aim is to reduce the crop failures by supplying supplemental irrigation water to the crops during the dry season and critical growth stages i.e. reproduction stage (flowering and grain formation). This is achieved by developing a surface runoff harvesting system using a relatively cheap water harvesting pond lined with a plastic liner to prevent the seepage losses. The pond is then covered with a floating water fern (Azolla-) which is an aquatic crop that grows on the water surface. Azolla suppresses mosquitoes by inhibiting ovi-positioning of the female mosquitoes that spread the malaria virus and also acting as a physical barrier for mosquitoes to lay their eggs on the water surface. A supplemental irrigation system under study is also tested using a crop water model developed by FAO (Aquacrop).

**Objectives** - The principle objective of this study is to develop a supplemental irrigation scheme for maize production under rain-fed agriculture. Maize is one of the major staple foods in Uganda and East Africa as a whole. In Uganda, maize production had increased over the years as people changed their consumption trends. It had started evolved from a purely subsistence to a successful commercial crop. However this very important move has been greatly altered by the changing climatic conditions. Changing rainfall patterns, uneven distribution and concurrent droughts have caused a tremendous drawback of this important shift in the farmers' lifestyle.

Maize in Uganda is sold mainly for food in schools, relief by World Food Program (WFP) or export to neighboring countries such as Kenya, Rwanda and Burundi. The study's objective is achieved through several simulation trials using FOA's Aquacrop water model and the cost benefit analysis to estimate the optimal pond size for surface runoff harvesting and water lifting techniques. The model also estimates the additional required amount of irrigation water to seasonal rainfall that should be supplied during the critical and water sensitive growth stage of the maize crop to reduce crop failure under water shortage.

This study is therefore a mitigation strategy for agricultural water shortage in the agricultural sector in mostly all the Sub-Saharan African countries with efforts to reduce the increased pressure of food security in the region.

### 1.3: Research Questions

What is the optimum pond size for surface runoff in supplemental irrigation that can maximize the net benefit from the pond, i.e. the increase in crop production minus the cost of water harvesting and supplemental irrigation?

How much additional crop yields (quantity) can be achieved by applying supplemental irrigation during the critical maize crop growth stages under the rain-fed agricultural system?

When is the break-even point for a supplemental irrigation scheme in rain-fed agricultural systems?

### 1.4: Research Approach

Due to insufficiency of adequate scientific data regarding the economic feasibility of rainwater harvesting for supplemental irrigation mainly in cereal production in Africa, this creates a big knowledge gap in the field of agriculture. Yet most of the African population depends on agriculture for their food demands. In particular, the rural farmers who are facing the huge effects of climate change such as constant droughts, floods and erratic rainfall which leave both their crops and animals destroyed. This research attempts to fill that knowledge gap by proposing a potential and feasible solution for the problem of water shortage.

The study proposes a supplemental irrigation scheme that focuses on harvesting surface runoff during the intensive rainfall events and uses the stored water during the periods of water shortage. The proposed scheme relies on rainfall due to the fact that the Sub-Saharan Africa has abundant rains though with changing patterns and distribution due to the effects of climate change. Another reason for relying on rainfall is that supplemental irrigation is basically applied to crops that can do well with rain-rain-fed agriculture, this means that even if there is a deficit in the irrigation water, the crops can still survive to a certain extent.

The study also uses a water productivity model from Food and Agriculture Organization (FAO) called Aquacrop to simulate for the potential benefits of both rain-fed and supplemental irrigation system in terms of crop yields. These benefits are used to make a comparison with the costs for the supplemental irrigation scheme so as to establish a cost-benefit analysis. The model is simulated using data from a study area in one of the Eastern districts of Uganda called Soroti.

Furthermore the study examines the economic feasibility of the proposed supplemental irrigation scheme by comparing costs and benefits for the different water harvesting pond capacities along with

different water lifting/application techniques. The system is more economical, easily adopted, and requires locally available means to implement either on large or small scale farming. The study also gives a detailed account on the collection, storage and application of surface runoff during the wet days for supplemental irrigation during the dry periods to increase agricultural production in the region.

Regarding the content description, the research study is made up of 6 chapters of which they present a detailed investigation of the potential of rainwater harvesting for irrigation under rain-fed agricultural zones. **Chapter one** consists of the introductory part about the global water shortage problem, Africa's future water crisis, regional food insecurity and agricultural water shortage, it also includes the statement of the problem, research goal, aim and the objectives of the study in addition to the research questions under investigation.

**Chapter two** is devoted to literature review and a background overview on rainwater harvesting for irrigation, important related terminologies, forms and types of rainwater harvesting and their application in the agricultural industry. **Chapter 3** gives a detailed description of FAO's water productivity model-Aquacrop. The model is used to simulate maize crop production under the function of water consumption for rain-fed and supplemental irrigation. Due the fact that supplemental irrigation is designed without a standard irrigation schedule, irrigation water is only applied if the soil moisture level reduces to a certain extent that could have a negative impact on the growth of the crops.

This level can be different for different crops since there are plants which are water sensitive like rice and maize and other plants which can still thrive under low soil moisture for some good time like sorghum and millet for the case of cereals. The simulation model is well elaborated under of this study giving a detailed account of its performance and input parameters. The chapter also introduces a cost benefit analysis framework of the proposed supplemental irrigation scheme, and formulations used in the cost benefit analysis.

**Chapter 4** gives an account of the proposed supplemental irrigation strategy. It identifies some commonly applied surface runoff harvesting techniques in Uganda, pros and cons of using excavated water harvesting ponds and a detailed framework of the proposed water shortage mitigation scheme. **Chapter 5** focuses on the details of the study area in the Eastern part of Uganda called Soroti, data collection and analysis. This chapter gives the scope of the study area's physical environment, climate, field study, soil sampling and laboratory analysis. It further presents the results from the model simulation, cost benefit analysis and discussion of the results. Lastly but not the least, **Chapter 6** presents the conclusion and the recommendations from the study.

## Chapter 2. **Background and Literature Review**

### 2.1: **Terminologies**

Since the study deals with irrigation practices, it's of a greater importance to first familiarize with the most commonly used terminologies related to irrigation.

#### **Evapotranspiration**

This is total amount of water lost into the atmospheres through two combined processes i.e. evaporation which is water lost from both the soil and water surfaces and transpiration which is the amount of water lost from the plant canopy more especially the leaves (Dusabimana, 2012).

#### **Crop water requirements (CWR)**

This is defined as the amount of water required to compensate the evapotranspiration loss from the cropped field (Dusabimana, 2012)

#### **Crop Water Need (ET crop)**

This is the amount of water that is availed to the crop to fully compensate for the crop's evapotranspiration needs to reach an optimal growth and result into the crop's potential production. It's always referred to as a crop growing in a stress free zone i.e. no water stress, no heat stress, no disease infection, active growth and favorable soil conditions (Brouwer & Heibloem, 1986).

#### **Irrigation Water Requirements (IRW)**

This is the extra amount of water supplied through irrigation required to fulfill the crop water requirements for a particular crop supplementing the natural rainfall in a rain-fed agricultural system. FAO describes IRW as the water difference between the CWR and the effective precipitation. IRW is equal to zero when there is enough rainfall and the amount of rainfall is enough to satisfy the crop water requirements resulting in optimum growth of the crop. IRW can also be equal to the crop water requirements if there is no rainfall at all, meaning all the water needed by the crop should be supplied by irrigation (Brouwer & Heibloem, 1986).

#### **Reference Evapotranspiration (ETo)**

This is the generic term referring to the potential of the atmosphere for evapotranspiration. It refers to the evapotranspiration of a short green grass, and the grass should completely cover and shade the ground surface. It should have a uniform height and the level of soil moisture in the root zone should be



enough to supply all the crop water needs. There are different methods to estimate the ETo, the following are the main methods to calculate it (Brouwer & Heibloem, 1986).

- **FAO Penman-Monteith equation** – In 1990 FAO took its stance in deciding the most standard and recommended method to calculate ETo from any area around the world and this is the Penman-Monteith Equation that was originally developed by Penman in 1948. The equation has been so far revised by different researchers for an easier application to different localities. Penman-Monteith method requires different climatic parameters for the meteorological centers to compute into the equation; among the parameters required are the sunshine or radiation data, air humidity, air temperature, vapor pressure and the wind speed data. The equation can be expressed as (Allen, Pereira, Raes, & Smith, 1998);

**Penman- Monteith Equation**

$$ET_o = \frac{0.408\Delta(R_n - G) + \gamma \frac{900}{T + 273} u_2 (e_s - e_a)}{\Delta + \gamma (1 + 0.34u_2)} \quad (1)$$

Where

ET<sub>o</sub> = reference evapotranspiration [mm day<sup>-1</sup>],

R<sub>n</sub> = net radiation at the crop surface [MJ m<sup>-2</sup> day<sup>-1</sup>],

G = soil heat flux density [MJ m<sup>-2</sup> day<sup>-1</sup>],

T = air temperature at 2 m height [°C],

u<sub>2</sub> = wind speed at 2 m height [m s<sup>-1</sup>],

e<sub>s</sub> = saturation vapor pressure [kPa],

e<sub>a</sub> = actual vapor pressure [kPa],

e<sub>s</sub> - e<sub>a</sub> - saturation vapor pressure deficit [kPa],

Δ = slope vapour pressure curve [kPa °C<sup>-1</sup>],

γ = psychrometric constant [kPa °C<sup>-1</sup>].

- The **Blaney – Criddle Method** – this is also a theoretical method that only uses the temperature data to estimate ETo. It's a simple method that is more recommended to be used in areas with high relative humidity, non windy and cloudy conditions. In most cases, the Blaney - Criddle method is not recommended to be applied in desert conditions.

The Blaney – Criddle equation is expressed as;

$$ET_o = p (0.46 T_{\text{mean}} + 8) \quad (2)$$

Where

$ET_o$  = Reference Evapotranspiration

$p$  = Mean daily percentage of annual daytime hours

$T_{\text{mean}}$  = mean daily temperature ( $^{\circ}\text{C}$ )

The value of  $p$  varies according to the latitude of the area (south or north of the Equator). Different  $p$  values are given by FAO in their training manual number no. 3 (Brouwer & Heibloem, 1986). This is the method which is used to calculate the  $ET_o$  values in this research due to the unavailability of the climatic parameters from the meteorological center which are required by the more accurate method of Penman.

- **Pan Evaporation method** – This method uses an evaporative pan filled with water in open surfaces to measure the rate of evaporation in that particular area. Pan evaporation is not recommended to be used with  $ET_o$  calculations on an hourly basis rather from 10 days and more. The amount of water lost from pan corresponds to the evaporative water demands of the area. The evaporation method integrates almost all the climatic parameters like wind, radiation, air humidity and air temperature (Allen, Pereira, Raes, & Smith, 1998).

Pan Evaporation Equation

$$ET_o = K_p E_{\text{pan}} \quad (3)$$

Where

$ET_o$  = reference evapotranspiration [mm/day],

$K_p$  = pan coefficient [-],

$E_{\text{pan}}$  = pan evaporation [mm/day]

Pan coefficients ( $K_p$ ) vary according to the type, size, color, shape and the positioning of the pan. FAO provides different  $K_p$  for different grass surfaces and varying climatic conditions (Allen, Pereira, Raes, & Smith, 1998).

The method has a few constraints. For example the pans can store heat during the day that may lead to loss of water during the night at a certain extent. This contradicts with the fact that crops only transpires during day however still the method is considered valid for  $ET_o$

calculations. Also there is a possibility of water reflection on the sides of the pan during the hot days and this may alter the accuracy of the results (Allen, Pereira, Raes, & Smith, 1998).

### **Crop evapotranspiration under Standard conditions (ET<sub>c</sub>)**

Crop evapotranspiration is defined as the evapotranspiration from disease free, viable, well fertilized crops, grown on a large scale with optimum soil water conditions which enables full production potential of the crop under the given climatic conditions. ET<sub>c</sub> can be expressed as;

$$ET_c = K_c ET_o \quad (4)$$

Where

ET<sub>c</sub> = crop evapotranspiration [mm d<sup>-1</sup>],

K<sub>c</sub> = crop coefficient [dimensionless],

ET<sub>o</sub> = reference crop evapotranspiration [mm d<sup>-1</sup>].

### **Crop Coefficient (K<sub>c</sub>)**

The Crop coefficient K<sub>c</sub> is basically the ratio between crop evapotranspiration (ET<sub>c</sub>) to the reference evapotranspiration (ET<sub>o</sub>). K<sub>c</sub> varies from crop to crop and it also varies at different stages of every crop. It represents an integration of the effects of four main factors that distinguish a crop from a reference crop. These are crop height, canopy resistance to vapor transfer, evaporation from the soil and the reflectance of the crop soil surface (Albedo) (Allen, Pereira, Raes, & Smith, 1998).

## **2.2: Rainwater harvesting (RWH)**

The idea of water harvesting which is generally referred to as rainwater harvesting has been under existence for thousands of years back. (Helmreich & Horn, 2009) (AbdelKhaleq & Ahmed, 2007). RWH is believed to have been first practiced in some areas of Iraq 5000years ago in the so called "Fertile Crescent" (Falkenmark, Fox, Persson, & Rockstrom, 2001). For so many years ago, water harvesting was used more frequently than rainwater harvesting, however, to so many authors, it has been defined interchangeably with rainwater harvesting (Critchley & Siegert, 1991) (Siegert, 1993) (Boers & Ben-Asher, 1982) (Falkenmark, Fox, Persson, & Rockstrom, 2001).

The term water harvesting was first defined by Geddes in the University of Sydney back in 1963 as "the collection and storage of any farm water either runoff or creek flow for irrigation use". It was also defined by Currier in 1973 as "the process of collecting natural precipitation from prepared watersheds for beneficial use". The same term water harvesting was defined by Frazier (1983) in his handbook as "the collection and storage of water from an area that has been treated to increase precipitation runoff" (Ramamohan Reddy, Venkateswara, & Sarala, 2014). FAO defines water harvesting in its broad sense as the collection of runoff for its productive use. Whereas rainwater harvesting is a type of water

harvesting in the form of rainwater and its runoff that is collected and concentrated for both domestic and agricultural use. Runoff may come from either roofs or ground surfaces (Critchley & Siegert, 1991).

Another relatively similar term is flood water harvesting which is the collection of discharges from watercourses like streams, rivers etc. for dam storages. Although in the past the practice of water harvesting was tailored and primarily designed for domestic purposes, scientists in Sub-Saharan Africa, MENA region and South East Asia have made efforts to transform and modify the practice to suit agricultural applications. So many techniques have been developed with a basis of the indigenous knowledge to collect and store rainwater for supplemental irrigation during the dry spells (Oweis, Hachum, & Bruggeman, 2004) (Humphreys & Bayot, 2009) (Biazin , Sterk, & Temes, 2012).

Rainwater harvesting is currently the best practice to mitigate the escalating issue of water scarcity in the tropical developing nations, for both domestic water use and agricultural production during the dry spell ( Baguma & Loiskandl, 2010). During the previous centuries, it was merely thought of as just a strategy to complement domestic water usage during the dry spells. However, it's now re-thought as a strategy to increase water supply for both domestic and agricultural uses in drought prone countries (Boers & Asher, 1982).

In an attempt to increase water supply for domestic use at household level, governments and other international organizations strongly suggest that poverty reduction measures should be conducted or implemented alongside with water shortage mitigation plans. Far beyond the household level, water harvesting helps to sustain the ecological system that in the long run brings about production in all aspects of humanity (UNDP, 2006).

This practice has previously been applied in the arid and semi-arid regions to mitigate drought problems. However it has also been adopted in humid and semi-humid regions (Sivanappan, 2006). Very simple technology has been put into use for both catchment and storage processes. Catchments processes may include rooftops, compounds, artificially prepared land surfaces, natural rock surfaces or hill slopes and lined pits. Whereas Natural or artificial ponds, reservoirs and dams for the latter process (Helmreich & Horn, 2009).

**Figure 2.1** illustrates the different components of rainfall event (R) after falling on the earth's surface. Soil evaporation ( $E_s$ ) ranges between thirty to fifty percent of the total rainfall (R).  $E_s$  can even be more than 50% in semiarid regions in case crops are planted in a sparse pattern (Rockstrom, 1997). Sparsely plated crops experience a high solar radiation, very high temperatures and stronger winds which may all bring about a greater turbulence and low production. (Falkenmark, Fox, Persson, & Rockstrom, 2001).

## Rainfall Partitioning

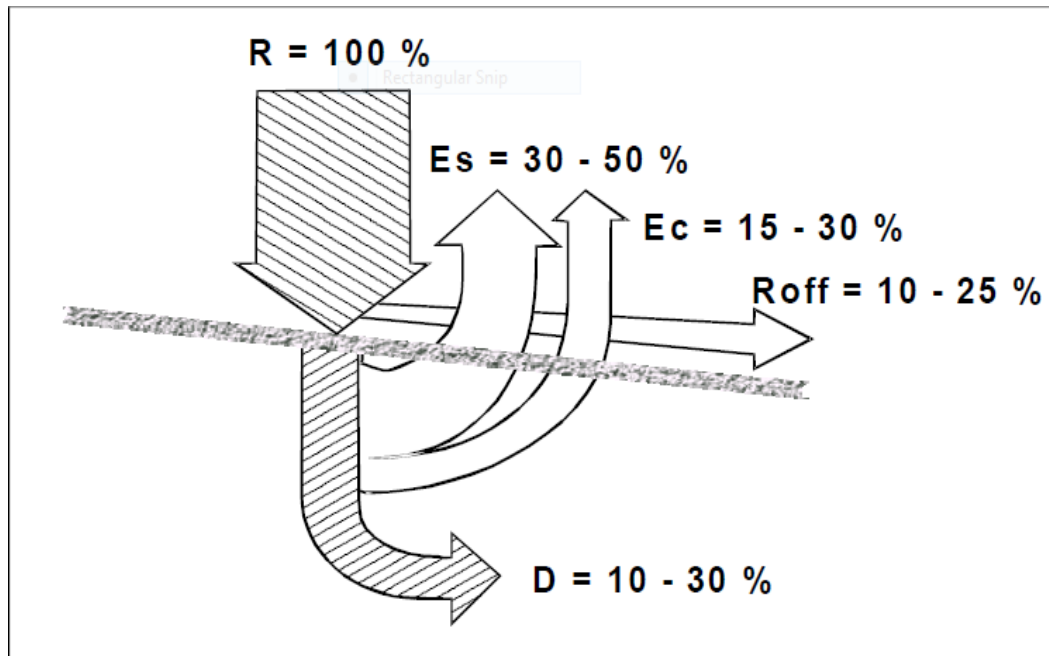

**Figure 2.1** Rainfall Partitioning into flow components in Rain fed Agricultural Areas

The different partitioning illustrates Rainfall as it falls on the soil surface  $R$  represents Rainfall,  $E_c$  represents Plant transpiration,  $E_s$  for Soil Evaporation,  $R_{off}$  for Surface runoff and  $D$  represents Deep percolation. Surface runoff is estimated to be 10 – 25 % and Deep percolation 10 – 30 % of the total rainfall (Casenave & Valentin, 1992).

### 2.2:1: Major forms of Rainwater Harvesting (RWH)

#### 1. Agricultural Rainwater Harvesting

Agricultural water harvesting is a practice where water is collected and stored mainly for agricultural purposes including livestock and irrigation. It may be divided into;

- In situ RWH: this is the practice of collecting rainwater immediately in that particular area where waterfalls and it infiltrates in the sub-surface soil layers (root zone) so as to be available for plant roots.
- External water harvesting: this system has two particular components i.e. a collection area and a storage facility. Where runoff from a faraway area flows to near-by low lying areas where it can be tapped and stored for future use.

2. **Domestic RWH (DRHW)** is a system where water is collected for home use. It can be collected from rooftops using gutters, courtyards, and other flat surfaces around home enclosures.

### 2.3: Concept for Runoff Harvesting

Runoff Harvesting aims at mitigating the effects of dry spells in mostly rain-fed agricultural zones to increase production as well as the water use efficiency (WUE) of the plants. However from the farmers' point of view, water harvesting is just a potential tool to stabilize the availability of water to the crops for a certain period of time. As illustrated from **Figure 2.2**, runoff harvesting is composed of 3 components i.e. the catchment area, storage and the cultivable area (Falkenmark, Fox, Persson, & Rockstrom, 2001).

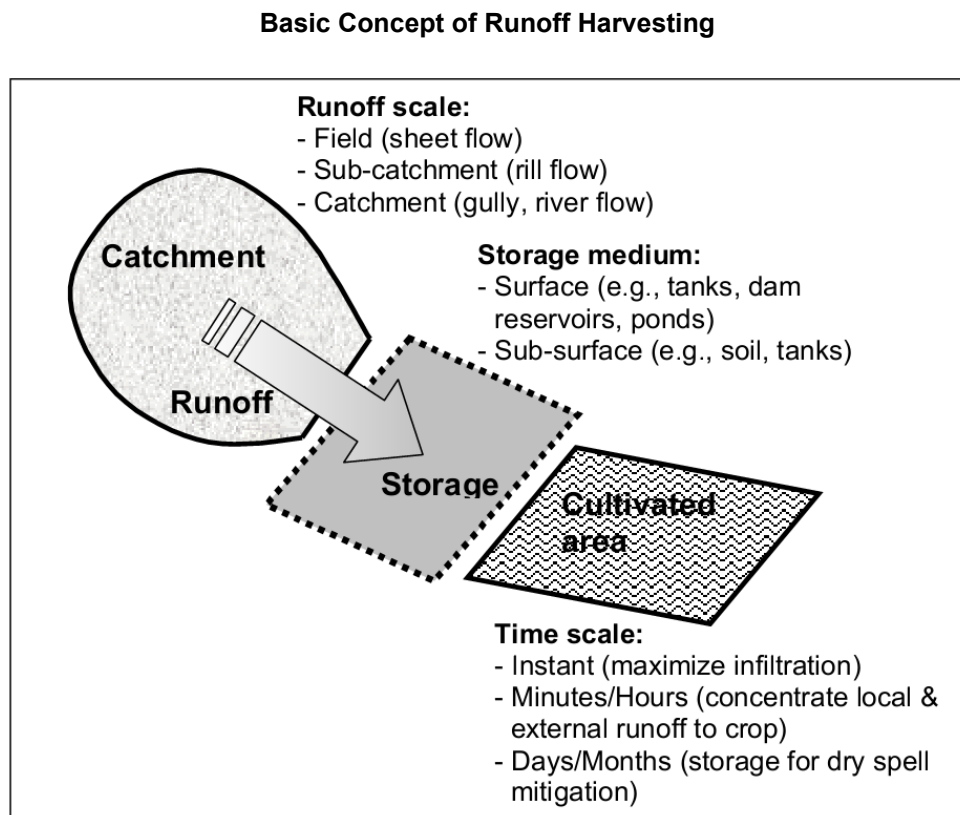

**Figure 2.2** The Basic Principle of Rainwater harvesting for Agriculture

The runoff scale from the catchment area could be of different types. For example, the sheet flow or the fields flow where excess runoff flows over an area in a form of a small sheet covering the land surface. It's mainly caused by heavy downpour or storms. The most common storage medium for sheet flow is the surface storage medium e.g. hedge rows, contours or stone bunds. These allow for instant or maximized infiltration of water into the soil however they are not suitable for mitigating drought effects since water can only be collected for a shorter period like minutes or hours and then it infiltrates into the soil.

The rill flow on the other hand does not cover the whole land surface, its only limited to some parts of the catchment. Rill flow can be of smaller sized channels over the land's surface (micro rills) or of enlarged channels (gullies). These rills guide runoff into low lying areas or to water storage medium if artificially established. Rills and gullies mostly guide water into sub-surface storage or low lying areas of the cultivable land such as dam reservoirs, surface ponds etc.. They help in mitigation of drought and dry spells since water can be collected for longer periods (Falkenmark, Fox, Persson, & Rockstrom, 2001)

## 2.4: Water harvesting systems and techniques

Due to variability in rainfall patterns and distribution in rain-fed agricultural zones, different water harvesting techniques have been developed to help cope up with the changing growing seasons of crops. Figure 2.3 gives an account of the water harvesting systems and techniques used in relation to their water sources and storage time span.

### 2.4:1: Water collection systems

- **Within field RWH** – This is the immediate collection of rain as it falls on that particular surface. Through various formations such as pits, contour bands, barriers and others. Water stagnates, infiltrates and percolates to the sub-surface soil layers where it becomes accessible to be taken up by the plant roots.
- **Flood/Gully WH** – This system comprises of different shapes of gullies that are used to collect or divert floods and runoff flow directly into a near-by field through bunds and terraces for a shorter storage period. It can also be stored in a storage facility and used in the near future during periods of water scarcity for long term usage.
- **Rill/Sheet flow WH** – In this system, the runoff collected from a smaller slope compared to the gully flooding. The difference between Flood/Gully and Rill/Sheet flow WH is that the Rill/Sheet flow slope is gentler and the catchment area is smaller.
- **Ground WH – Pumping** water from underground and at the same time storing it in underground reservoirs eliminates the possible losses of water through evaporation and it contributes to its quality most especially if the aquifers are not located in contaminated zones.

**Roof RWH** – Roof Rainwater Harvesting is the most common system of rainwater harvesting all over the continent. Its easily applied and requires no special skills to be installed. This system is feasible in areas with physical structures like households and farm buildings where the harvested water is just enough to cater for the basic water needs at home or for backyard gardening. Gutters are installed around the roof of the house and connected to drain pipes that eventually drain water to a constructed tank besides or near the house (Falkenmark, Fox, Persson, & Rockstrom, 2001)

## Water harvesting techniques in Sub-Saharan Africa

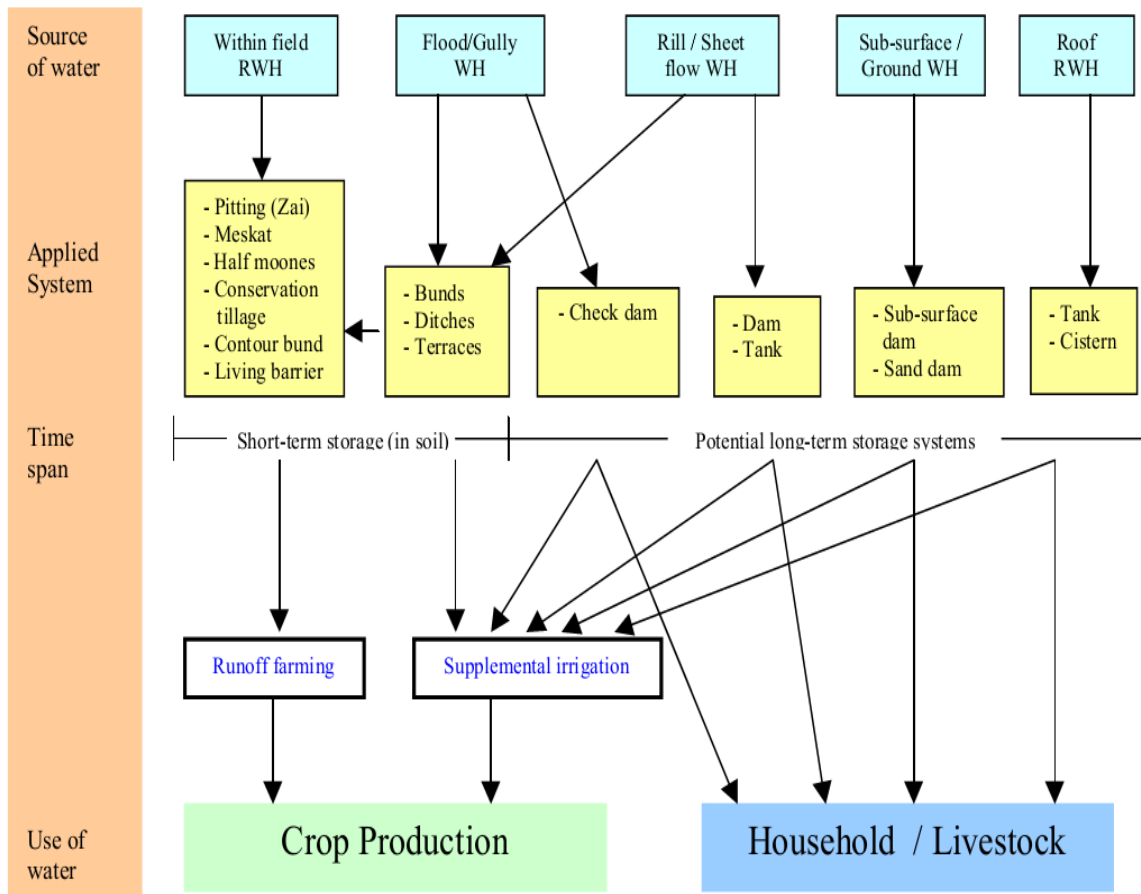

**Figure 2.3** Different water Harvesting techniques classified according to their water source and the storage time span. (Fox, 2001)

### 2.4:2: Water Storage systems

- **Micro-dams, earth dams, farm ponds.** These facilities are commonly used to store water on a small-scale. The structures are not very sophisticated ranging from micro concrete-dams to simple earthen dams.
- **Macro-dams, Sub-surface dams, sand dams or check dams.** These are a bit more improved facilities where water is collected and stored underground. Water is trapped with a strong concrete or clay walls and then stored for longer periods to be used in periods of scarcity.
- **Tanks.** These can be made of different materials like cement, plastics and clay. They can be fixed below the soil surface or raised above the ground depending on the available space.



## 2.5: Rainwater harvesting and management (RWHM)

This phenomenon encompasses the whole package of the water harvesting system including collection, storage and utilization (Ngigi, Savenije, Rockstrom, & Gachene , 2005). The practices which are applied in Sub-Saharan Africa include traditional practices for maximizing water penetration into the plant root zones hence enhancing water availability for the crops. Water conservation within the soil can be achieved through micro-systems however long-term water storage for dry spell mitigation is mainly achieved using the macro-system and also other techniques for improving water use efficiency for the crops on the farm.

### 2.5:1: Micro-catchment systems

Rainwater harvesting using the micro-catchment systems are designed and tailored to collect surface runoff for a short-term period. Most of the micro catchment systems cannot cope with the dry spells that would last for several days, however such practices tend to minimize crop losses in case of short droughts. This is true because micro techniques are in most cases are designed to collect and store water for a very short period of time. They are mostly used to reduce soil erosion and maximize water infiltration. The water is collected from a relatively small catchment area of not more than 500m<sup>2</sup> on the farm enclosures. The runoff from the catchment area is guided by structural enhancements which increases the rate of infiltration of water into the root zone as illustrated in Figure 2.4. (Biazin , Sterk, & Temes, 2012).

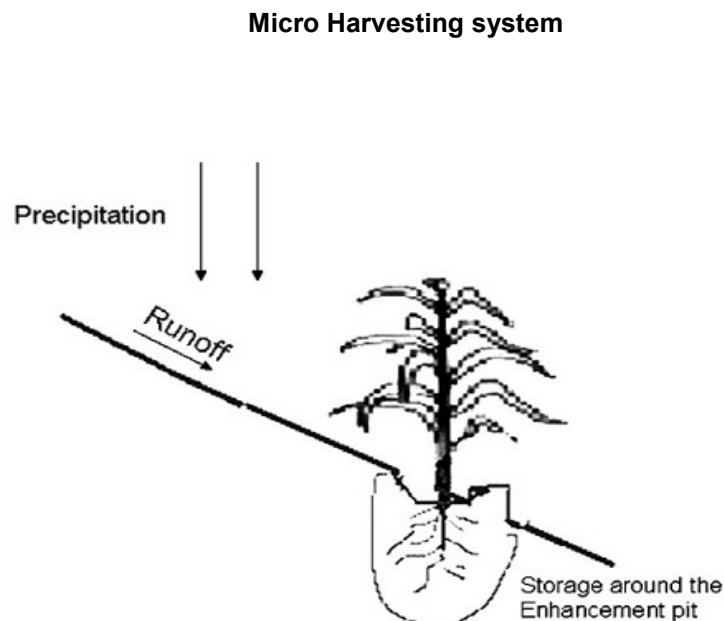

**Figure 2.4** Typical designation of the micro-catchment rainwater harvesting systems.

The micro-catchment systems are often the most adopted systems due to the fact that they are easily controlled and can be easily replicated. The ratio of the catchment area to the irrigated target area can vary between 2:1 to 10:1 (FAO, 1991). The commonly applied techniques for micro-catchments in Sub-Saharan Africa are summarized in Table 2.1.

Most of the applied techniques in the different parts of Sub-Saharan Africa may have different local names but actually have minor differences with respect to their design and purpose. For instance the Pitting system which has been commonly practiced in West Africa for the last decades in particular Burkina Faso, Mali and also in the Ethiopian highlands in East Africa. They have been called different names like the zai or tassa pits in West Africa, ngoro pits in East Africa, however they all serve the same purpose.

**Table 2.1** Micro-catchment rainwater harvesting in sub-Saharan Africa (**Biazin , Sterk, & Temes, 2012**)

Type of the Micro-catchment systems	Description	Regions where applied
<b>Pitting</b> (Zai pits, Ngoro pits, trenches, tassa pits, etc.)	<p><b>Zai pits:</b> Commonly found in agricultural areas with rocky surfaces and sometimes the pits are supplemented with manure before planting.</p> <p><b>Ngoro pits:</b> These are more like shallow traditional pits where crops are grown on the ridges of the pits.</p> <p><b>Trenches:</b> These are mainly applied on hilly areas or slopes in mostly an alternate pattern to facilitate water infiltration and reduce surface run-off.</p>	<p>West African countries mainly Burkina Faso, Mali, Niger.</p> <p>East Africa mostly Tanzania, Kenya, Somalia, Uganda, Ethiopia.</p> <p>South Africa</p>
<b>Contours</b>	<p><b>Stone and soil bunds:</b> Piles of stones or soil can be stack at different points in an agricultural plot just to interfere with the surface run-off from the up hills. The piles or bunds can be associated with perennial grasses or herbs for ensuring a strong fixation in that particular place.</p> <p><b>Hedge rows:</b> Grasses, shrubs or herbs are used as natural barriers on contours to counteract surface runoff and aid infiltration of water into the soil.</p>	<p>Common in East Africa i.e. Kenya, Ethiopia, Tanzania and South Africa</p>

<b>Terracing</b>	Terraces can be formed of different shapes and sizes; they can be semi-circular or continuous and can also be established along flat plains or hilly slopes. However what makes the <b>Fanya Juu terraces</b> different from other terraces, is that their embankments are put in the upslope position	Typical of East Africa in Kenya and Tanzania in addition to Ethiopia
<b>Micro-basins</b>	Micro-basins are short-term water storage systems aimed at improving water infiltration to the root zones of plants, they are commonly practiced on relatively flat plains. They are constructed in varying shapes like diamond shapes, Halfmoons and eye brows.	Typical in East Africa i.e. Ethiopia, Kenya, Tanzania and Uganda.  West Africa mostly in Burkina Faso, Mali and Niger.

These pits are more likely the same but with different names For example the Zai pits in Burkina Faso which are dug 60 by 60 cm apart and a maximum of 4 seeds of sorghum sown on each pit (Slingerland & Stork, 2000). Another similar system called the Tassa pitting is more practiced in the dry deserts of Niger where holes are made with an average size of 25cm by 25cm in depth and diameter. They are dug with 100cm between holes just to act as pockets for rainwater for an improved infiltration (Kaboré & Reij, 2004). The Ngoro pitting system is applied more in the steep areas of Tanzania to trap more water and increase soil moisture in the root zone (Malley, Kayombo, Willcocks, & Mtakwa, 2004). Contours and Terraces made of stones and soil bunds are widely spread in East Africa in countries like Tanzania, Uganda and Kenya in addition to the small micro-basins of different shapes and sizes (Abdulkadir & Schultz, 2005) (Spaan, 2003).

#### 2.5:2: **Macro-catchment systems**

In this kind of system, water is mainly collected from external areas which can extend to 2 ha or in some cases catchment areas as large as 50km<sup>2</sup>. Macro-catchment systems are composed of 4 essential parts i.e. the water catchment area, water storage structure, a target irrigation area and a supplemental irrigation system as shown in Figure 2.5. The harvested water may either be used for supplemental irrigation in crop lands or for domestic consumption (Biazin , Sterk, & Temes, 2012).

Variations in system designs are often most especially with respect to size ratio of the catchment area and the cultivated target area. Runoff is collected on natural slopes or sometimes on paved surfaces

that facilitate and guide the running water to the storage facility. The system of upslope runoff has proved to be successful in so many parts of Botswana (Carter & Miller, 1991).

Among the mostly applied macro-catchment techniques in Sub-Saharan Africa (SSA) include micro-dams, sand dams, open pond reservoirs, cisterns etc. All these techniques are not completely new inventions but they are either traditional practices or modified indigenous practices.

### Macro harvesting system

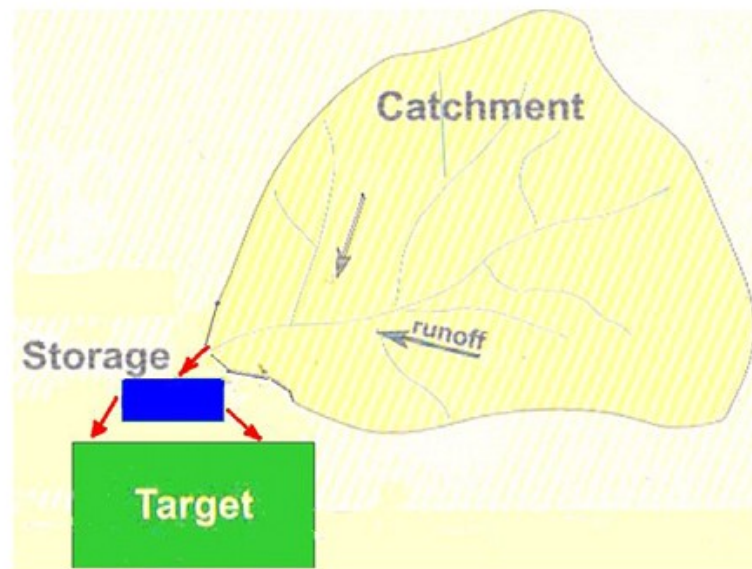

**Figure 2.5** A typical designation of the macro-catchment rainwater harvesting systems.

Localized techniques with a somehow similar design but with few modifications and different names in different parts of the continent serving different purposes have been developed as shown in Table 2.2. For example the birkas (runoff-underground tanks) and the hafir (low earth dams) which are used in Eastern Ethiopia and the ellas (deep wells) in the Borena area of Ethiopia which are primarily used for domestic purposes and livestock. The caag system practiced in the Hiraan region of Somalia has proved to be efficient in areas with overland flow (Biazin , Sterk, & Temes, 2012).

Traditional open water ponds are commonly used in Sub-Saharan Africa due to their low cost of establishment and their ease of implementation. However the system does not last for too long most especially after the rainy seasons due to the impact of seepage and evaporation. Seepage is the most serious problem commonly experienced in the earthen reservoirs where water losses can reach up to 69% of the harvested water (Fox & Rockstrom, 2003).

Another serious challenge related to open water ponds is the breeding of mosquitoes since the exposed water surface acts as a breeding place for the deadly malaria spreading mosquitoes. In contrast to the traditional open water ponds and their related challenges, there has been a new development in the region which has overcome all these challenges to a greater extent, the cistern system. Cisterns are artificial water reservoirs; especially underground water tanks which are covered to reduce evaporation and mosquito ovi-positioning.

The most essential requirements/materials for the establishment of cisterns is cement which does not seem to be financially feasible for the local poor farmers in Sub-Saharan Africa. Therefore, they're not easily adopted and not widely spread across the continent. However these costs can be reduced to a greater extent by using the locally available materials in the construction of cisterns. For example in Ethiopia, termite-mound earth has been utilized to develop cisterns at a low cost (Mills, 2004).

Additionally through its initiatives, the Ethiopian government has gone an extra mile to construct more than 340,000 cisterns in the main four administrative regions of Amhara, Oromia, Southern Region and Tigray in just a single year between 2003 and 2004 (Bekele, Kebede, Taddese, & Peden, 2006).

In Tanzania, rural farmers make use of dugout ponds created as a result of soil excavation along road sides which are under construction where rainwater is collected, stored and they are used for domestic use, vegetable production or livestock.

**Table 2.2** Macro-catchment rainwater harvesting (Biazin , Sterk, & Temes, 2012)

Macro-catchment Systems	Description	Storage capacity (m <sup>3</sup> )	Countries of wider application
<b>Traditional open ponds</b>	Surface runoff from hilly areas, road ways, pathways, or even cattle tracks is collected into earthen open ponds; however, the system experiences high levels of evaporation and seepage losses.	30–50	East African region - Kenya, Ethiopia, Tanzania, Somalia
<b>Cisterns</b>	Surface runoff from any external area either cultivated or	30–200	East African Nations: Kenya, Ethiopia, Tanzania,

	non-cultivated sloppy area is directed to underground storage facilities which have cemented walls and closed surfaces. Prior to the entry point of the water to the tank is a settling basin for sedimentation		Uganda.  South Africa (Zimbabwe, Botswana)
<b>Earthen dams (micro-dams)</b>	Earthen dams are similar to open traditional ponds because they are neither cemented nor covered but the difference is that most of these dams are communally established and are quite bigger in size. The system is more commonly applied in Tanzania and Ethiopia.	30 – 100	East Africa – Tanzania and Ethiopia.  Southern Africa - Botswana  West Africa - Burkina Faso
<b>Sand dams</b>	Stronger dams with strong concrete walls are constructed to store naturally flowing water from streams and seasonal rivers. Sand settles a few meters away from the water storage facility.	>200	East Africa - Kenya and Ethiopia
<b>Ephemeral stream diversions and spate irrigation</b>	These diversions are aimed at securing water for irrigation of		East Africa – Tanzania, Eritrea and Ethiopia,

	the near-by farms using the flooding system prior the planting time.		
--	--	--	--

Another common technique is applied in Sub-Saharan Africa is known as the spate irrigation. Heavy floods flowing for a short duration can be diverted and spread all over the crop field. It's an indigenous practice which has gained a lot of recognition in so many countries most especially in Sudan, Kenya, Eritrea, Ethiopia, and Somalia (Tesfai & Stroosnijder, 2001)

All of the macro-systems mentioned in Table 2.2 can be used to store water for a longer period than the micro catchment systems. These techniques can store water long enough to be used for mitigation of dry spells and droughts. Traditional open ponds and earthen dams are capable of storing enough water for supplemental irrigation if managed and designed in a sustainable manner. They could be of different sizes and shapes, established at the lowest point of the farm for maximizing runoff collection. Such structures are easily implemented through community efforts and family labor mostly because of their low costs of production compared to the other systems.

However the biggest challenge posed by these structures is the great deal of water losses through seepage and evaporation which reduces their efficiency. The cisterns and sand dams are quite bigger and expensive structures which can collect any amount of runoff depending on the size and location of the facility. They consist of strong cement walls which prevent water from seepage and evaporation to a certain extent if covered on the top surface. They are commonly developed by local or governmental authorities but not on individual basis.

## Chapter 3. **Water shortage Mitigation Scheme**

### 3.1: **Common Water Harvesting Techniques in Uganda**

Ambiguous weather patterns brought about by the impacts of climate change have been responsible for the untimely planting patterns of crops due to the fact that rains are becoming erratic and unpredictable in so many agricultural areas in Uganda. For this reason, Ugandan farmers who are completely depending on rainfall for agriculture are finding it very difficult to produce their crops in the absence of rains during the periods when it is expected. Rains are torrential and making matters worse, they are unevenly distributed around the agricultural zones. For this matter therefore farmers have resorted to rainwater harvesting systems using ponds to store water and use it in dry spell periods.

In Figure 3.1, there are 3 different water harvesting technologies. Tank 1 represents the mostly practiced water harvesting system for home consumption or domestic usage. This system uses plastic tanks of different sizes raised off the ground and connected to the gutter system which is established all around the house roof to collect water and store it in the tank. Such tanks have a volume between 1 – 3 m<sup>3</sup> of water storage. This practice is relatively cheaper compared to other systems however it requires a bigger roof surface area and can only be used at home not in the agricultural field.

Tank 2 is an underground concrete tank which is mostly used for collecting surface runoff for irrigation of crops and watering of animals. It can be constructed with different capacities and shapes but it requires a higher capital investment to construct the tank which might not be afforded by most of the Ugandan farmers. The volume ranges from 3 – 5 m<sup>3</sup>. Farmers can only opt for such a system if they have access to agricultural bank loans or if the government has put up programs to develop such establishments but at a lower or subsidized cost.

For the case of Tank 3, it's a round concrete underground tank which could be used for two purposes i.e. collecting water for domestic or home consumption in addition to water for horticultural crops and livestock. This system is characterized with a bigger pond volume of more than 5,000 m<sup>3</sup> of water since it's a multipurpose system. It's also very expensive to construct by an average farmer in Uganda. Unless farmers can borrow money from the banks or community financial groups to develop the system with hopes to increase their agricultural production in terms of yields to pay back the loans in the negotiated period. Even though it's quite an expensive system, its economic value is greater since it's a multi-purpose system with a higher durability.



### 3.1.1: Plastic and concrete water storage medium



**Figure 3.1** Different water harvesting technologies (FAO T. , 2012)

### 3.1.2: Earthen Pond water storage

Since this study proposes a supplemental irrigation scheme using an excavated water pond, it's of a greater significance to familiarize with the different pond storage medium. Water ponds or sometimes called pans are simple excavations for storing surface runoff dug out in open areas. These ponds have an average depth of about 2 - 3m while their area are dictated by the size of the catchment area and the required amount of water to be collected for a certain period of time. These two terms (pond and pan) are most times used interchangeably. Ponds are in most cases established in areas where there is a high water table to assist in refilling of water in periods of low rainfall where as pans refer to reservoirs that can only be filled with surface runoff.

Ponds are developed in a way that they can receive water from different surfaces such as cultivated areas, sidewalks, hillsides, open grasslands, roads and any other water guiding surface. The storage capacity of ponds varies from 500 – 5,000m<sup>3</sup> of water. Ponds or pans are usually constructed on gentle slopes of less than 2% or 1:50. At such a slow slope, erosion effects are very minimal and the construction process is easier because water will have to run from a steeper area to the lowest point making site selection to be easily determined (Mati, 2015).

The catchment area should be gently sloping to allow for a mild flow of surface runoff till it reaches the pond site. Also the catchment area should be of a relative size to the excavated pond in that it should not be that big to have excessive runoff or over storage leading to flooding. It should also not be of a plain rocky surface i.e. it should be of considerable grassland or composed of bushes enough to trap most of the silt and other unwanted trash.

### 3.1:3: **Pros and Cons of an excavated water pond**

Excavated water ponds have been used for quite a long time in different agricultural regions. However they have some advantages and disadvantages. Amongst the greatest benefits of water ponds over other water storage facilities is that it can store relatively large quantities of water. Ponds can collect water for multi uses such as crop irrigation, drinking water for animals and also some domestic uses if constructed near the homestead. Their structure very simple and precise and can be fitted anywhere on the farm provided it can collect the required amount of surface runoff. They can also be easily maintained due to the fact it requires only periodical removal of silt which requires no skilled labor (Mati, 2015).

On the other hand, huge excavated ponds have some disadvantages and among them are: Ponds can have a negative impact on the environment and the soil physical structure which may lead to catastrophic effects like landslides and earthquakes. Large ponds can be a sole cause of malaria outbreak in the surrounding areas as they can be breeding areas for mosquitoes. Collected runoff may be contaminated and polluted from wide catchment areas. Their durability is smaller compared to other structures like concrete sub-surface dams. These structures also register greater losses through seepage and evaporation if not taken care of. Deposition of silt in the pond and Low capacity compared to valley dams (Mati, 2015).

### 3.1:4: **Different types of Earthen water ponds**

#### **1. Water Pans**

These are small water reservoirs which are mainly excavated in open grounds for both crops and livestock watering. Pans can be made of different shapes such as square shape, rectangular shape or moon shaped (hemispherical), as shown in Figure 3.2. Pans are most preferred in catchments where there is no farm cultivation in that the ground areas are just open grass lands, hill slopes, pathways or main roads. These facilitate undisrupted flow of surface run off into the reservoir.

The main draw backs for pans are their high rates of siltation, low storage capacity, evaporation losses and seepage losses. They are mostly established in semi to arid areas where animals have few or no water streams to drink from.



**Figure 3.2** Excavated water Pans

## 2. Water Ponds

Just like pans, ponds are also excavated water reservoirs of a considerable size in comparison to the catchment area and the required water to be collected. The maximum depth of ponds is 3m although most of the excavated ponds for water harvesting are of 2m depth. The storage capacity of a water harvesting pond can range from 100 – 5,000m<sup>3</sup> of collected water. The water storage facilities with capacity less than 500 m<sup>3</sup> of water are referred to as tanks where as the ones with a capacity of more than 5,000m<sup>3</sup> are referred to as dams (Mati, 2015).

Water ponds are mainly used for supplemental irrigation of crops, some few for animal watering in addition to other domestic uses. They are in most cases established in areas with a high water table to facilitate pond recharge in cases of low rainfall amounts. However this does not work well in arid areas because the water table is very low, meaning pond recharge by the underground water table is minimal; water is only harvested from surface runoff too just like the water pans. Figure 3.3 shows typical water harvesting ponds. 9(a) and 9(b) represent the earthen ponds while 9(c) and 9(d) are lined ponds with plastic pond covers.



**Figure 3.3** Different Water harvesting ponds

### 3.2: Supplemental Irrigation (SI)

In many of the rain-fed agricultural zones, low crop yields are attributed due to low soil moisture, inappropriate management of soil and other field practices. Shortage of soil moisture due to short droughts and dry spells especially during the critical crop growth stages (flowering and grain filling or formation) can lead to severe losses of crop harvests. Such challenges can be mitigated through the application of supplemental Irrigation as a strategy to minimize or reduce crop failures. Supplemental irrigation is the application of limited amounts of water during critical crop growth stages to essentially rain-fed crops to improve and stabilize yields by maintaining a minimum amount of soil moisture in the root zone. (Oweis & Hachum, 2012).

Contrary to a full irrigation system, a supplemental irrigation system cannot be easily planned in advance since it relies on the variability in rainfall events. There are three fundamental aspects that are considered to design a supplemental irrigation system:

- Rainfall being the main source of water for rain-fed agriculture, supplemental irrigation is meant to be applied only when there is a shortage in soil moisture that can induce a negative effect on crop production leading to an unstable production.
- Supplemental irrigation is supplied to crops that are normally produced with rain-fed system and they can do without any irrigation to produce significant yields.
- The planning of a supplemental irrigation system is not essentially based on provision of a moisture stress-free condition into the soil. But rather, it is planned in a way that, the timing and amount of irrigation water is optimally scheduled to provide the minimum soil moisture required to give an optimal yield (Oweis & Hachum, 2012).

### 3.2:1: **Schedule of supplemental irrigation**

**Time-plan of application:** Supplemental irrigation does not require a fixed schedule or standard fixed plan as it is with a full irrigation system. It is very difficult to accurately plan the timing and amount of water to be applied in advance for this system since it is dependent on rainfall. The fact being that rainfall is becoming more erratic and unevenly distributed. This variability in rainfall patterns due to the effects of climate change creates a greater challenge to a local, uneducated farmer to figure out when is the right time to apply irrigation. Rural farmers lack technical knowledge of how to estimate low soil moisture in the root zone unless they rely on their experience. Of course there exists standard equipment and tools to measure soil moisture levels such as the tensiometers, however such tools are quite expensive to purchase and require skilled personnel to operate or conduct the tests.

Other instruments which could be used are either very advanced or so complex for a farmer to use. This leaves no choice for a farmer to measure soil moisture except relying on his/her experience for example observing a change in the crop vegetation like drying of the leaves, feeling of the soil dryness in the palm and /or observing a longer period without rainfall. Such practices may lead to excessive application of irrigation water and also poor management of the water during its critical need and plant stress.

**Depth of water application:** Depending on the available amount of water for irrigation, it may not be possible to have a full supplemental irrigation. The farmer can decide to irrigate back to field capacity which is unlikely because of the shortage of the irrigation water. Or else irrigation can be applied to some few millimeters below the field capacity. Unlike supplemental irrigation, most farmers prefer always a fixed net application of 30mm per ha of irrigation water if it's a full irrigation system. However in this case for supplemental irrigation which is not on a fixed schedule but only applied during water shortage in soil root zone, it needs a good planning and weather prediction to have an estimate of how many irrigation events would be supplied. If not, then the farmer still has to depend on his experience to choose the right amount of water to apply while saving for the next expected irrigation events in case of a dry spell.

## Optimization of Supplemental Irrigation (SI)

Although SI can be used as a mitigation strategy to reduce crop failure in rain-fed agricultural systems, it cannot guarantee the highest performance in production. Other additional management practices should be put in place to ensure additional increment in yields such as soil amendment practices, adding organic fertilizers, using improved crop varieties etc. Improving soil fertility directly enhances the yield and water use efficiency of crops under cultivation. Most especially with the macro-nutrients i.e. nitrogen, potassium and phosphorous which are of a greater significance to improve the soil physical and chemical characteristics.

Additionally replacing local seed breeds with the improved varieties which are more tolerant to harsh weather conditions like drought and resistant to common crop diseases such as the bacterial and fungal infections.

### 3.3: Feasibility of Supplemental runoff irrigation in macro-systems

There has not been enough published data concerning the economic feasibility of rainwater harvesting in Sub-Saharan Africa and more specifically the financial feasibility of surface runoff in particular. However with more attention and development on supplemental irrigation, it is believed that there is a potential to reach more than 30 million poor people by just applying the practice to 15.2 million ha of agricultural lands out of the 42 million ha of irrigable land in the region (Chartres, 2009).

Some researchers have reported the increase in yields for cereal crops including maize after supplying supplemental irrigation water to the crops during the critical need (Pandey, Zaag, & Soupir, 2013) (Panigrahi, Panda, & Mull, 2001). In their studies, they made it clear that the seasons which experience more rainfall or the ones that didn't experience frequent dry spells had relatively similar yields with the rain-fed system without irrigation.

This was also presented in the previous studies by Pandey, et al. (2013) that supplemental irrigation during the wet years or during the seasons with high rainfall could not produce different yields from the rain-fed system alone. Sometimes actually the yields are the same. This means that supplemental irrigation using ponds could only be profitable during the dry years or seasons that frequently experience dry spells

Other studies have showed that water storage ponds of about 100mm of supplemented water during the crucial dry spells, can double rain-fed cereal yields from about 1 to 2 tons per hectare, increasing water productivity to 0.5 kg/m<sup>3</sup> of water consumed (Biazin , Sterk, & Temes, 2012). This means that a rainwater tank of 50m<sup>3</sup> could be used to supply irrigation water to an agricultural plot of 500m<sup>2</sup> land which can double the yields in just one season.

### 3.4: Overview of Cost Benefit Analysis

The cost benefit analysis is a technical tool used by researchers to compare the financial benefits of a project in comparison to the baseline scenario where the project has not been put under consideration. Generally there are two kinds of cost-benefit analysis i.e. Financial cost benefit and social cost benefit analysis.

The financial cost benefit analysis mostly applies to individual costs and benefits for a given project. The economic benefits are only related to personal interests, profits and decisions made by that particular person. While the social cost benefit analysis puts into consideration the costs and benefits on communal basis. The whole analysis is based on the decisions and interests of the society where the project will be implemented or conducted from. (Benicke, 2001).

There is no huge difference between these two types of cost benefit analysis except the view or point of adoption. Like in real life situations, personal benefits may not that be similar to society benefits. Additionally personal benefits may be more of short term targets and society benefits are mostly long term goals. Also for social cost- benefit analysis, there are might be incidences where some other benefits might be of great significance or consideration than the financial benefits for example the environmental and health benefits (Benicke, 2001).

As shown in Figure 3.4 this study considers the financial cost benefit analysis since the study focuses on individual establishments of an irrigation strategy by implementing a surface runoff harvesting pond on privately owned land. The catchment area in this case may or may not be owned by the farmer himself but since surface runoff isn't that easily controlled, it can be collected from any part of the huge vast nearby uncultivated catchment areas, be it roads, pathways, farm boundaries, established furrows, bushes and so on.

The general rule for the calculation of the cost benefit analysis is the analysis of the total inputs and the total output benefits for the study project and transforms them into a monetary form for better comparison of the results. If the total inputs are more than the total outputs, it simply means that the project will not be feasible and it will be rejected. On the other hand if the total benefits are greater than the total inputs, the project proves to be feasible and it gets accepted by the stakeholders (Griffin, 1998).

## The Cost Benefit Analysis Framework

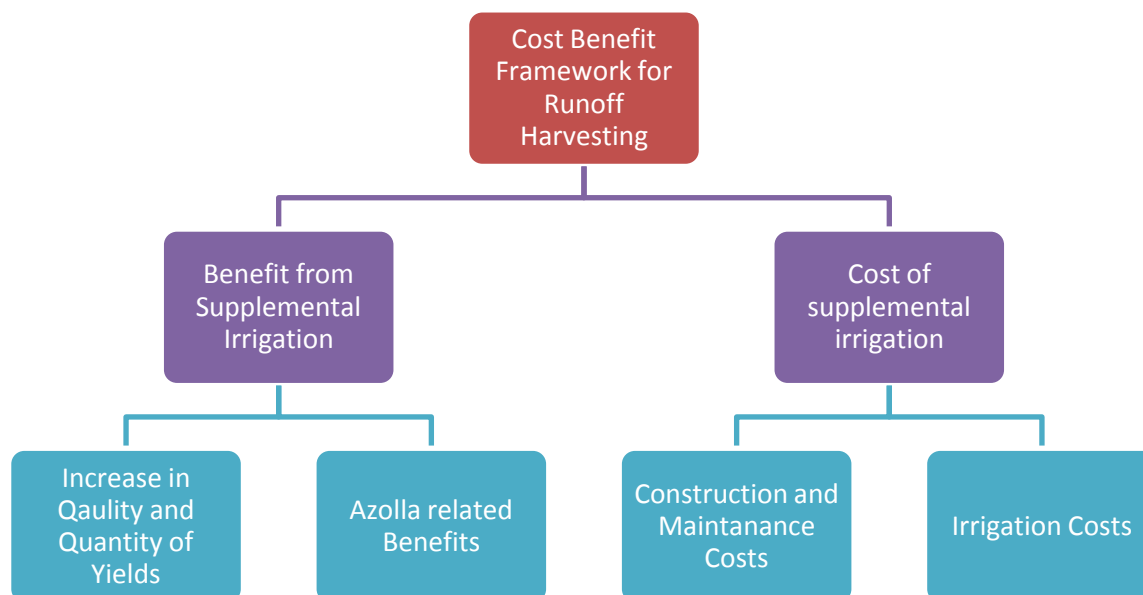

**Figure 3.4** Cost Benefit Framework

Figure 3.4 depicts a simple framework that is used in this study to develop the cost benefit analysis for the proposed supplemental irrigation system. The total costs include the capital costs for the construction of the pond, the materials used to establish the pond (e.g. the pond liner), maintenance of the pond, the costs for the irrigation tools and the operation cost for the irrigation system. The system benefits include the increase in quality and quantity of crop yields and the benefits related to the cultivation of azolla both economic and environmental benefits. More details about the cost-benefit analysis are presented in Chapter 4.

### Formulations

The pond volume and dimensions are estimated using an equation from (Masser & Jensen, 1991). **Pond Volume** = surface area x average depth.

Average depth in meters is only used when the pond has no uniform depth. This applies mostly to ponds which are inclined towards the drainage side or overflow side.

The pond liner dimensions are estimated using the pond liner calculator (WaterGardeningDirect, 2017) which uses the formulae in meters.

**Pond liner size** = (maximum length + (2\* depth) +1) x (maximum width + (2\* depth) +1).



However in this study, there is an assumption for excessive overflow of the pond to be somewhat higher since the catchment area experiences some erosion. For this matter therefore, the overlap liner is extended 2 m from all edges of the pond. The overlap part of the liner is prevented from sunlight exposure by covering it with a heap of soil creating a band of soil around the water pond.

In the development of the cost benefit analysis which is discussed later on in details in Chapter 4, there is a need to calculate the annual depreciation of the water lifting techniques. The following equations are used to calculate the annual depreciation.

$$\text{Annual Depreciation} = \text{Working of a machine in a year (hours)} \times \text{hourly depreciation rate} \quad (5)$$

$$\text{Hourly Depreciation} = \frac{\text{Original cost of machine} - \text{Salvage value}}{\text{Estimated life of machine in hours}} \quad (6)$$

Estimated life of machine in hours

### **Average Annual growth**

Agriculture in Uganda has an average growth rate of close to **3%**, it's among the sectors which the Ugandan government accords primary concern through its national development plan that aims to move the country to a middle income status by the year 2020 (G. o. U. Office of the Prime Minister). Also in the cost benefit analysis, there is need to calculate average annual growth specifically for the study area for predicting the value benefits of the proposed scheme. It reflects the decrease or increase from year after year yields. The Annual yield is calculated with the following equation:

$$\text{Annual Yield Growth} = \frac{\text{Yield in Present year} - \text{Yield in Previous year}}{\text{Yield in Previous Year}} \times 100 \quad (7)$$

Other details related to the formulations of both the pond and the cost benefit analysis is presented in the later chapters.

## Chapter 4. Study Area – Soroti

### 4.1: The physical environment of the study Area

The study area is located in Eastern Uganda and bordered by Amuria district in North-North East and Katakwi to East, then Kaberaimaido to the Western border. On the Southern part, it is bordered by Serere and Ngora districts. Formerly all these districts that surrounds Soroti district were part of Soroti and were recently split by the current government. Soroti district is located between geographical coordinates of 1.541° to 2.029° North and 33.39° to 38.82° East and at an on average elevation of 1125 m above MSL. The Nearby major town is Kaberaimaido town, Amuria, Serere, and Ngora towns which are approachable by roads.

The map of Uganda showing the study area



Figure 4.1 Map showing Soroti - the study area in Eastern Uganda

The following reasons attributed to choosing Soroti as a study area:

- Soroti is located in the Eastern region of the country in the famous low lying cattle corridor of Uganda. The cattle corridor Figure 4.2 is the most drought vulnerable region of the country. This region swathes across the country from the southwest to the northeast with 97 districts inclusive. With the effects of the current climate change, agricultural production of these districts more particularly Soroti will highly be affected.
- The Uganda Bureau of Statistics in collaboration with the government's ministry of Agriculture (UBOS/MAAIF, 2010) Reported that maize production has been profoundly highest in the Eastern region of the country.
- Soroti was the third district across the nation with the highest maize production with over 15,000 ha of cultivable land of maize. And maize being the staple food across the nation and East Africa as a region, this makes Soroti
- The area is also a semi-arid climate with a generally flat or gently sloping landscape with intermittent rains causing occasional floods and heavy droughts. This means that with small scale affordable surface runoff irrigation schemes, farmers in the area can be able to sustain their production and reduce the chances of crop failures.

#### Uganda's Cattle Corridor – A dry agricultural zone

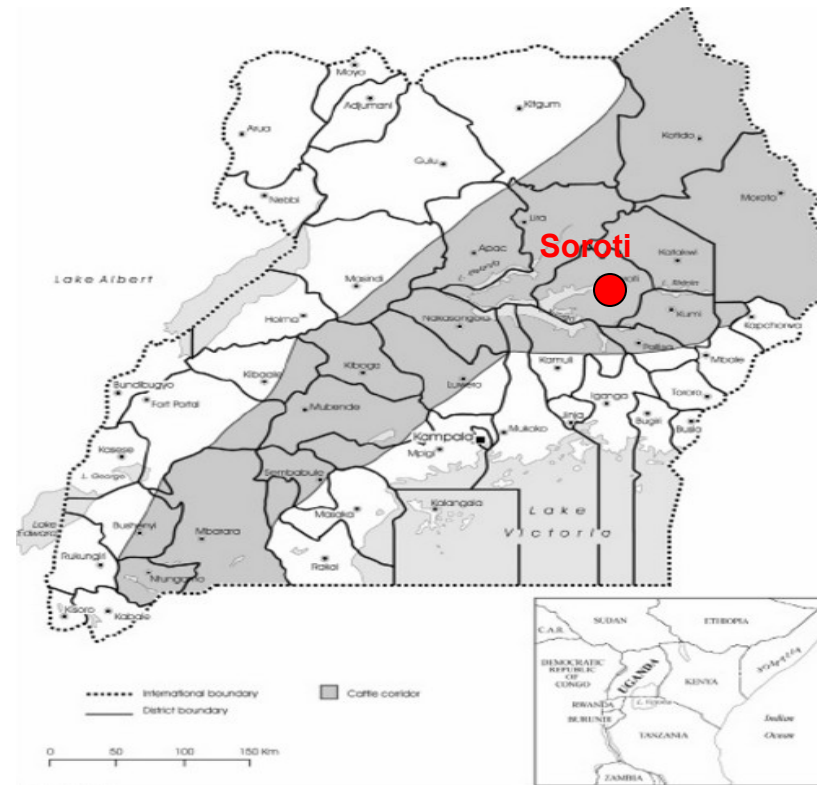

Figure 4.2 Uganda Cattle Corridor (Dark grey area stretching from South west to north east). (Steece, 2011)

## 4.2: Topography and Climate of Soroti District in Uganda

The study area's terrain is generally flat, with elevation ranging between 1000- 1250 mm above sea level and is traversed by numerous swamps and other ravine wetlands. Annual rainfall averages 1100-1200 mm distributed between two seasons of March to July and September to November (Basalirwa, 1995). Late November to late February or early March is traditionally the long dry season and mid-June to late July is the short one but this has become variable with frequent drought spells causing famine (MWLE, 2007).

The meteorological data was collected from the National meteorological department of the Ugandan Government in Kampala. The data included daily rainfall in mm/day for ten years from 2003 to 2012, daily minimum and maximum temperature in degrees centigrade for the same period. Despite the fact that it's a National Meteorological center, it was so unfortunate that some climatic data was missing. For example relative humidity historical data for the study area was missing; the wind speed, sunshine or radiation data was also missing from their records. This might have been due to lack of qualified personnel and tools to measure such parameters in a remote weather station in the study area like Soroti.

## 4.3: Rainfall patterns, distribution and seasons

In the South, Uganda's rainy seasons run from March through May and from September through November; these rainy periods are segregated from each other by two dry seasons; a drier one that starts in June and a fairly wet one that starts in December; these run through August and February respectively. The north however has a single wet season that extends from March to November with the dry season starting in December through February (Mubiru, Komutunga, Agona, Apok, & Ngara, 2012). The first wet season running from March through May on average receives more rainfall than the second wet season that starts in September through November, with rainfall peaks for the two seasons occurring in April and November respectively.

The south-western and north-eastern areas, bordering north-eastern Rwanda and south-western Kenya respectively, experience the least precipitation annually with rainfall amounts below 1000mm. Districts like Moroto in the north-east are semi-arid and prone to drought. On the other side, north-central areas including Gulu district and regions around the shores of Lake Victoria are the wettest, with annual rainfall amounts reaching 1500mm. The general average annual precipitation in Uganda is presented in Figure 4.3.

With regard to trend, the past 25 years have shown a general decline in rainfall amounts. It's for example evident that regions practicing crop cultivation have had an average decline of around 8% when rainfall amounts between two periods, 1920 to 1969 and 2000 to 2009 are compared.

The optimum rainfall amount required for agricultural production is about 500mm; the bulk of which is received between March and June. Over the past quarter century, the area receiving this adequate rainfall amount during the March-June rainy season has been shown to diminish, with further contraction expected if a similar trend persists (Mubiru, Komutunga, Agona, Apok, & Ngara, 2012).

Regions in both the west and north of the country are the most affected by the decline; areas in the northeast, south and northwest of Fort Portal, Gulu and Bombo districts respectively already experience below optimum rainfall amounts for viable agricultural production. A similar trend has been observed for the June-September rainfall season in the North. When the observed trend between 1960 and 2009 is projected to the period between 2010 and 2039, rainfall amounts received in parts of northern, northwestern, western, southwestern and eastern Uganda are expected to show a change of approximately -50 mm during the June-September season while most regions will experience -20 mm decline in rainfall amounts during the March-June season.

**The map of Uganda showing the mean annual rainfall in different regions**

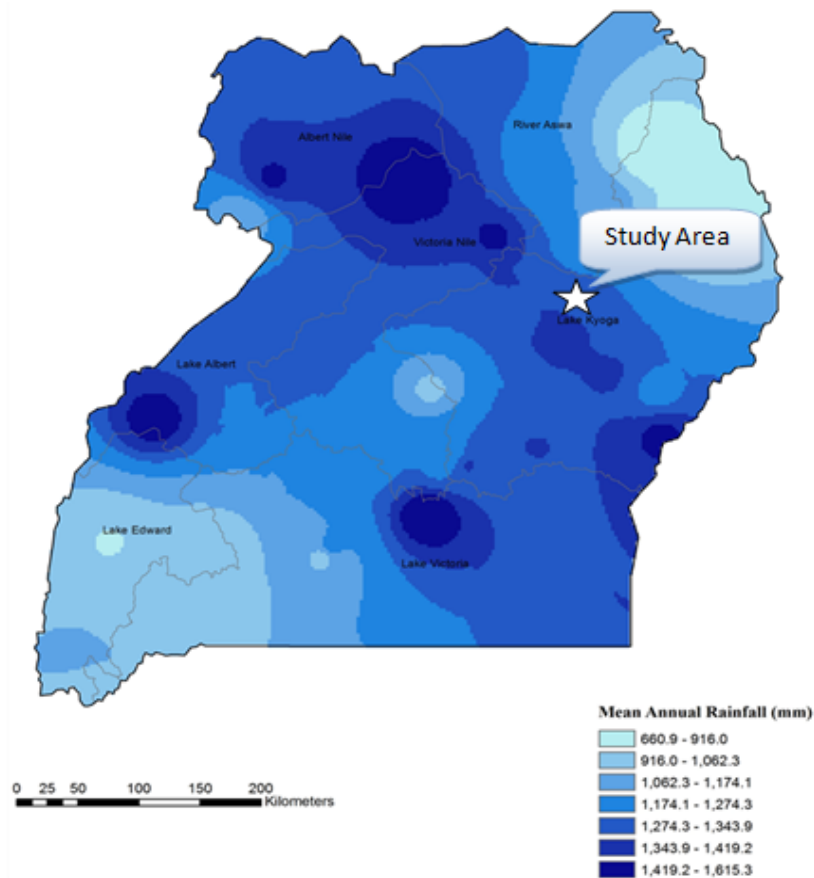

Figure 4.3 Uganda mean annual rainfall in main drainage sub-basins. (Nsubuga, Namutebi, & Ssenfuma, 2014).

Soroti, one of the districts in eastern Uganda lies within the SE L. Kyoga agro ecological zone; with a bimodal mean annual rainfall of more than 1200 mm, major crops grown include cotton, finger millet, cassava, and maize among others (Kansiime et al., 2013). The district is located within Uganda's cattle corridor illustrated Figure 4.2, which is a broad stretch of land running from the southwest to the northeast of the country, encompassing over a dozen districts; this stretch of land experiences extreme rainfall variability along with droughts due to late onset of rains.

From several years back, this part of the country was occupied by pastoralists who used to move from place to place with their cattle looking for better pastures. They never had permanent settlements or residences, they were always on the move with their cattle all over this corridor which made the whole area overgrazed and the land lost its fertility value. As a result, occupants of the cattle corridor changed their lifestyle and resorted to growing crops most especially cereals. However this happened when climate change had already changed the weather patterns of the area and this has caused serious calamities like drought, hunger and floods in the region (Stark, 2011).

Soroti district has specifically experienced a series of extreme climatic conditions such as the wide spread floods and drought. These whether extremes have negatively affected agricultural production through both decreased crop yields and complete crop failure (U. Office of The Prime Minister & UNDP, 2014)

#### 4.4: Land Use in the study Area

##### 4.4.1: Crop Production

Agriculture is the backbone of the economy of Soroti district. Over 75% of the households depend on subsistence farming as their principal source of livelihood. The sector provides employment to over 80% of the active rural population (MAAIF, 2010). The district has a high potential for a wide range of agricultural products, both crops and animals. According to records available in the Agricultural department, only 40% of the area is currently under cultivation.

The major income source is agriculture which includes livestock and crop production. Crop production in the study areas is the major income source with cereals especially maize and millet as the major produce. 53% of the district households are farmers (Nabikolo, 2009). Agricultural production is the main enterprise in Soroti area therefore gaining an understanding of the current production systems and constraints will help inform the feasibility for any proposed irrigation scheme.

##### 4.4.2: Maize production

Maize in Uganda is grown in multiple agricultural systems that vary in not only climate and elevation, but also in the socioeconomic aspect of the locals. Generally, it requires deep, well

drained fertile soils in a well ploughed but moderately rough field. Although maize performs well at several altitudes (0 to 2900 meters above sea level), certain varieties perform optimally at specific altitudes with 30 degrees Celsius being the most conducive temperature for growth (NAADS, 2013). Annually, Uganda has two main growing seasons which coincide with the rains; these range from March to May and September to November Figure 4.4.

**Uganda Maize Crop Calendar for Different parts of Uganda**

<b>Northern Season</b>												
<b>Eastern Seasons</b>												
<b>Southern Seasons</b>												
<b>Months</b>	J	F	M	A	M	J	J	A	S	O	N	D
<b>Key</b>	<b>Sowing Season</b>				<b>Growing Season</b>				<b>Harvesting Season</b>			

**Figure 4.4** Uganda's growing Seasons (FAO, Global Yield Gap Atlas, 2013)

The Northern part has only one long growing season which runs from March till September, the Eastern part has two growing seasons, the first growing season runs from March to July and the second one from September to December. The Southern part also has two growing seasons like the Easter part just with a simple difference that in the south, planting for the first season begins in February. Figure 4.5 shows a farmer and his wife hand weeding their maize field in the study area.



**Figure 4.5** Farmers hand weeding a maize plantation

Maize is therefore planted at the beginning of these seasons in March or April for the first season and also September for the second season depending on the country location. Planting depth ranges from 2 to 3 and 5 to 10 centimeters for wet and dry soils respectively, with a spacing of 75 by 30 centimeters for most varieties and 2 to 3 seeds per hole. A larger spacing is observed if intercropping is practiced (MAAIF & NARO, 2011b).

Nitrogen, phosphorous and potassium are the main nutrients required by maize and these can be acquired from either organic sources such as farm yard manure (FYM) or from industrially manufactured inorganic fertilizers. Also, weeding is another key practice if high yields are to be realized; this is usually performed manually by using hand held implements such as hoes but herbicides are also used to a small extent. In addition, it is recommended that the first weeding be done within the first 21 days of planting (NAADS, 2013).

#### 4.4:3: **Maize water Requirements**

Maize or corn is the most water efficient crop amongst all the cereal crops. Adequate moisture is required for the proper growth of maize; moisture should not go below the recommended amount during three key stages, which include establishment or the initial vegetative stages, tasseling and silking i.e. flowering and pollination stage for the last two stages as illustrated in Figure 4.6. These three stages are very sensitive to moisture stress due to the fact that if the soil moisture depletes below the reach of the plant roots, very great loss to the final yields is registered. This is because these are the stages which the plants initiate growth, produce tassels and silk and the grain formation follows.



However the most critical stage for moisture need during the whole growth cycle of maize is the period of flowering, when the maize crop is developing the tassels which are the male corn flowers as well as the female flowers which are referred to as the silk. Preceding the establishments of both flowers, pollination occurs, so in-case of a dry spell and there is no water in the soil, the flowers may fail to form and if they manage to form, the male flowers may dry out before the female flowers have developed because they don't develop at the same exact time.

### Maize Growth Stages

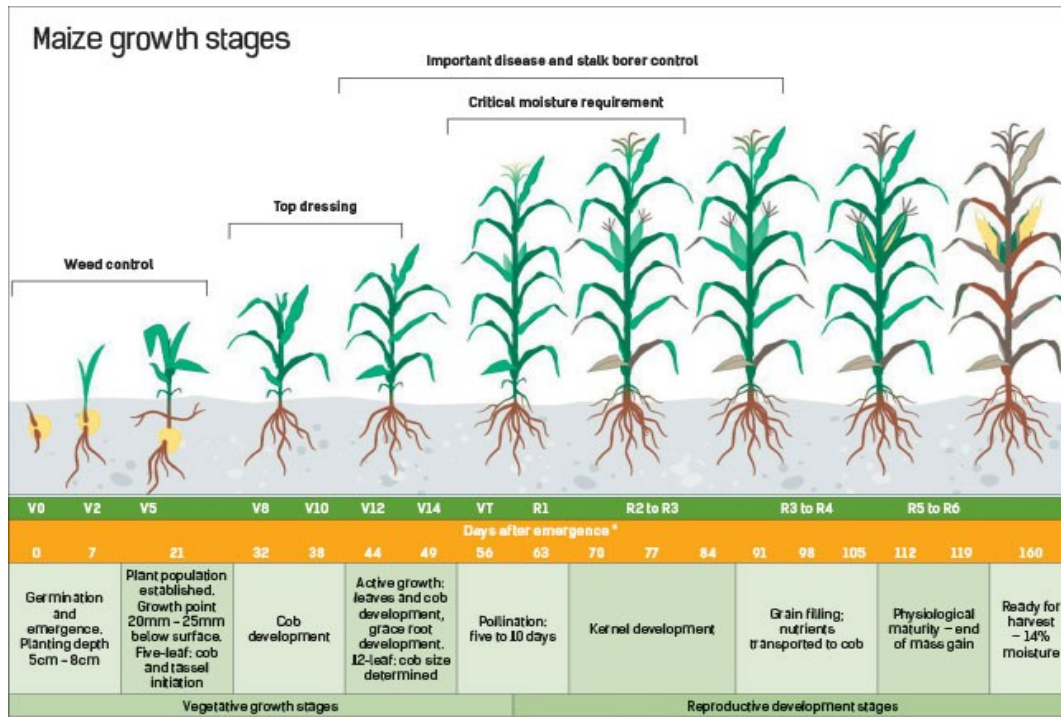

Figure 4.6 Maize growth stages (PANNAR, 2016)

The maize crop needs between 500 – 800 mm of water per season depending on a variety of factors for instance type of soil, seed variety, climatic conditions, and cultivation practices and so on. Each For the best yields, an optimal rainfall amount of 200mm is essential in the first five weeks of planting for both establishment and tasseling (NAADS, 2013).

The maturity period for commonly used hybrid varieties such as Longe 4, Longe 5 and Salongo ranges from 100 to 120 days while some few local, unimproved varieties may take much longer (NAADS, 2013). When fully grown, maize is harvested; this is commonly done by hand through breaking the cobs away from the stalks and drying them. An alternative method is to let the maize to dry in the field and later harvest and store the cobs after removing the husks.

Harvesting should coincide with the dry season to ensure adequate drying of grain which is then stored in either cribs or silos (MAAIF & NARO, 2011a).

After the harvesting and drying process, maize grains are taken to the market for sale. Maize prices have long been fluctuating for the last ten years due to the low yields all around the nation. By the end of the first season of the year 2017, the prices of maize grain stood at an average of As of July 2017, wholesale and retail prices for maize stood at UGX 900 (approx. USD 0.25) and UGX 1200 (approx. USD 0.32) per Kg respectively (Infotrade Uganda, 2017). The fluctuation in prices mainly depends on the incidences of drought occurrence, if there were incidences of drought in most parts of the country during the planting seasons. The prices are always high compared to seasons which were not affected by drought.

#### 4.4:4: **Charcoal Burning**

Soroti is blessed with the presence of key wetlands; a larger part of the district is covered with wetlands, forest reserves and grasslands. However, a lot of trees and other woody vegetation cover are increasingly being depleted through excessive grazing of livestock, charcoal and brick burning, clearing land for cultivation, and excessive tree cuttings as shown in Figure 4.7.

These factors are due to high population increase and unsustainable utilization of natural resources, poverty, desire to increase per capita income, low levels of technology, low levels of environmental awareness, and introduction of fruit growing. Charcoal burning is quiet rampant in the district.



**Figure 4.7** Deforestation for Charcoal burning

#### 4.5: **Soils and topographical surveys of selected areas in Soroti district**

An assessment of soil properties and their response to management is required in planning for agriculture and other land uses. Soil survey involves determining the pattern of the soil cover and dividing this pattern into homogeneous units, and mapping their distribution and characterizing them (Kaaya, Balthazar, & Mrhvia, 1994). The soil physical and chemical properties can be used in so many models and tools to estimate the potential of soil for

production purposes which is the main focus of these survey. The study employs the FAO water model (Aquacrop) that requires both physical and chemical soil properties for its analysis.

#### 4.6: Profile soil sampling and laboratory soil results

Soil samples were taken from three sub-counties in Soroti district which included: Ogweri, Arapai and Assuret in February 2017 and tested in the lab for their chemical and physical properties. The samples were taken from 5 different sites in the study area whose soil types have been classified by Chenery (1960) as shown in Figure 4.8. Most of the soil in the study area is classified as plinthosols which are characterized by the presence of iron and aluminium oxides giving it more of a red colour. These soils are very shallow and they often form hardpans with repeated wetting and drying which eventually lead to erosion (Driessen & Deckers, 2001).

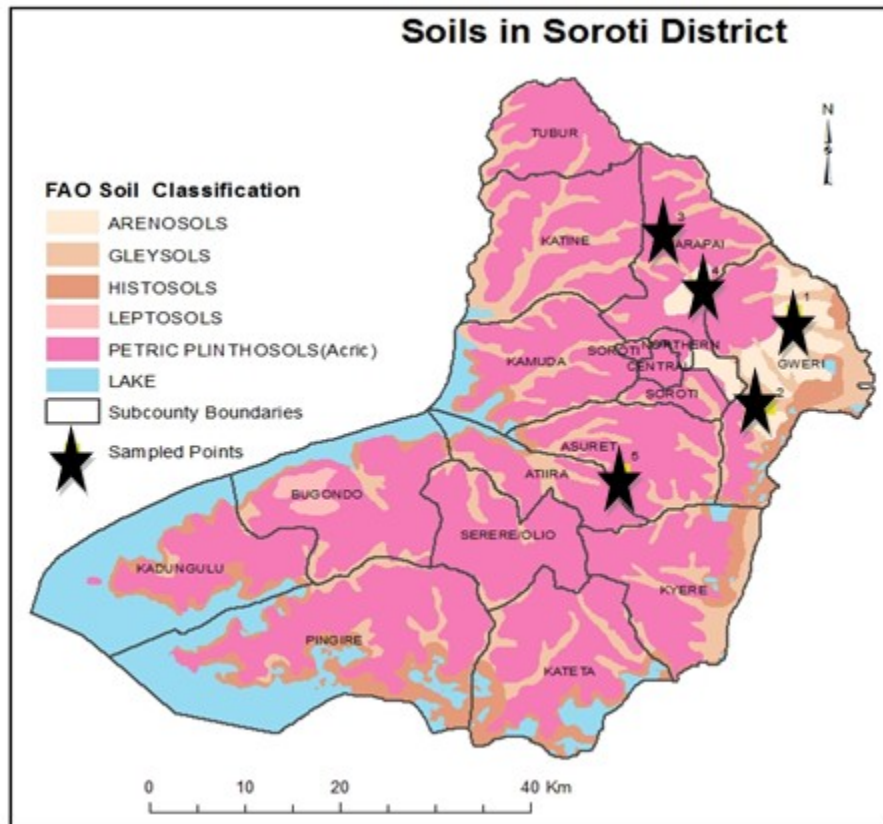

**Figure 4.8** shows the soils types in Soroti district under FAO classification

The samples under examination were collected from the upper soil horizons (0-30 cm) and in the subsoil layers (30 cm to 60 cm) in each site under different soil types in the area. The area has a soil hard pan due to the fact that most of the soils in the study area are petric plinthosols as explained earlier.

#### 4.6:1: Soil Physical Characteristics

The soil physical characteristics were obtained from both field surveys, observations and laboratory analysis and these include: soil profile, depth, soil color, soil erosion hazard, surface stoniness, slope , altitude and soil textural class got directly from the field while the soils particle size distribution from laboratory analysis as shown in Figure 4.9 and Table 4.1.



**Figure 4.9** Soil sampling in the study area

Surface Stoniness can directly influence the rate of soil erosion whereby an area with a stony surface and with no vegetation cover is very prone to soil erosion than the areas without a stony surface. Through continuous field visits, observations and consultation from the local farmers, we were able to get data related to surface stoniness and the rate of erosion in the area.

### The soil physical characteristics of the study area

Profile pits	Lat	Long	Slope%	Altitude (mm)	Depth (cm)	Drainage	Erosion Hazard	Surface Stoniness
1	1.7782	33.7379	1-3	1037	90.0	Poorly drained	Average	Nil
2	1.6777	33.6185	1-3	1035	70.0	Poorly drained	Average	Nil
3	1.8620	33.6183	1-4	1035	90.0	Well drained	Slight	Nil
4	1.8050	33.6515	2-5	1038	80.0	Well drained	Slight	Nil
5	1.6120	3357640	2-5	1038	80.0	Well drained	Slight	Nil

**Table 4.1** Summary of the site characteristics of the studied soil

#### 4.6:2: **Laboratory Analysis**

The soil samples were air-dried, pounded and sieved through 2 mm sieve to remove any debris then subjected to physical and chemical analysis following standard methods described by (Okalebo, Gathua, & Woomer, 2002) for routine analysis. Soil pH was measured in a soil water solution ratio of 1:2.5; Organic matter by potassium dichromate wet acid oxidation method; total N determined by Kjeldhal digestion; exchangeable bases from an ammonium acetate extract by flame photometry (K<sup>+</sup>, Na<sup>+</sup>) and atomic absorption spectrophotometer (Ca<sup>2+</sup>, Mg<sup>2+</sup>); and particle size distribution (texture) using the Bouyoucos (hydrometer) method (Okalebo, Gathua, & Woomer, 2002).

#### 4.7: **Effective Rooting Depth**

The effective soil depth of the sampled points is characterized as moderately deep. The extensive area is covered by deep rooting plants more than 70 cm, this rooting depth is suitable for most cereal crops like maize, sorghum and millet. The study area exhibits a soil hardpan at an average depth of 100cm as it can be seen in Figure 4.10. Soil depth is a constraint for agricultural development projects that requires more than 100 cm depth.



**Figure 4.10** Soil pit for soil sampling

#### 4.8: Elevations, slopes and Soil Erosion Harvard

The areas lie in lowland areas with the altitude of 1000 - 1250 meters above sea level (MSL). Most of the profile pits that were dug fall in a slope range of one to five percent (1% -5%). The sign of soil erosion hazard is slight in the area being covered by thick grasses and vegetation.

The surface cover of the study area is not characterized with coarse fragments of stones which in some cases poses a threat to irrigation projects. The area lies in the Lake Kyoga drainage basin which is one of the biggest drainage basins across the country.

#### 4.9: Irrigation Practice

Since the majority of Uganda's agricultural systems are rain fed, the recent changes in rainfall distribution patterns have severely impacted crop yields, including those of maize. In the first growing season of 2005 for example, over 20 percent crop loss was experienced nationally for banana, maize, beans and coffee as a result of drought; maize crop losses were over 25% and almost 40% in Eastern and Northern Uganda respectively (Mwaura & Katunze, 2014). One strategy to mitigate such crop loss is by incorporating various irrigation practices into the different agricultural systems all over the country.

It is evident from Tanzania, a report showed that irrigated agricultural systems perform much better in terms of yield than rain fed systems for both maize and bean crops (The World Bank, 2013). Unfortunately however, of the approximately 560,000 hectares of irrigable land available in Uganda, only 14,418 hectares are actually irrigated; most of these are associated with large commercial farms and represent about 2% of the total irrigable land. Such a low percentage is in part due to over reliance on rain for agricultural production (Kavuma, 2010).

The government currently has in place a 25 –year irrigation master plan which it rolled out in 2010 with the aim of assessing the feasibility, approach and cost of establishing irrigation schemes all over the country. In the master plan, two types of irrigable land are spelt out; the first is category A, which represents lands close to permanent bodies of water like lakes and rivers while the second, category B, represents those areas far from permanent water bodies requiring water storage facilities like valley tanks or dams.

The goal of the plan is to increase the area of category A land under irrigation from 25 to 70% by 2020 and 2035 respectively. Soroti district's irrigable area stands at approximately 9,275 hectares with category A and B areas representing 8,585 and 690 hectares respectively. With water bodies representing 15 percent of Soroti's total area, the government plans to prioritize category A areas for irrigation scheme development in the region (Kavuma, 2010).

To deliver water to fields, a number of irrigation techniques can be employed depending on prevailing circumstances; these mainly include surface irrigation, in which gravitation force is exploited to apply water to the field through three different ways which are: basins, furrows and borders; whereas basin irrigation involves flooding an entire flattened field (basin); basins are surrounded by bunds to keep the applied water confined and mostly used to grow rice. Furrow irrigation on the other hand utilizes channels (furrows) that deliver water to a field as they run downwards along a slope. Water infiltrates into the soil to the root zone as it moves through the furrow.

Additionally, border irrigation involves delivering irrigation water using long strips of sloping land demarcated by bunds on either side. The second irrigation type is sprinkler irrigation, in which sprinklers are used to spray irrigation water pumped and delivered by pipes onto crops, mimicking rainfall. Lastly, the third type is drip irrigation, which involves delivering irrigation water under pressure, through a framework of pipes to the field, where it's slowly emitted through drippers, wetting only the adjacent root zone of the plant located next to the dripper; it has thus been shown to be an efficient irrigation method (Brouwer, Prins, Kay, & Heibloem, n.d).

All irrigation methods, involve obtaining water from a source and distributing it within a field (Siraco Irrigation, 2017); Uganda is abundantly blessed with a multitude of water bodies including

lakes and rivers from which irrigation water can be tapped. Water bodies specifically in Soroti, occupy about 15% of the district's total area, of which Lake Kyoga is the most important.

The district therefore has a relatively adequate supply of water that could be utilized for irrigation; this is true especially for category A lands that lie in close proximity to such water bodies. However, despite these abundant water resources, irrigation scheme establishment in Uganda faces one tremendous obstacle, which is the cost of infrastructure required to transfer, store and distribute water to farmers' fields. The high capital investment involved makes the adoption of irrigation by small holder farmers almost an impossible.

Within the country's irrigation master plan, the government intends to cover the costs of water transfer from water bodies to irrigable land gates, after which farmers are expected to cover three fifths of the distribution costs to their fields while the government takes on the remaining two fifths (Kavuma, 2010). Although such an elaborate policy is in place, it prioritizes category A lands while insufficiently considering category B lands that are located further from major water bodies.

#### 4.10: **Proposed Supplemental Irrigation system**

Despite the fact that, supplemental irrigation is not a routine application, it's only done occasionally when required. This means that we require a temporary, mobile and flexible system for water application to the crop lands. This study does not give full details of the specific design of the pond. However it proposes and examines alternative pond volumes (400, 600, 800 and 1000) in cubic meters with their respective surface areas. These volumes are used because through model simulations, the maximum runoff that can be collected annually from a catchment of one hectare in the study area is found to be 1000 cubic meters and the lowest runoff is 400 cubic meters. For this matter therefore, there is no need to have a pond that exceeds 1000 cubic meters volume neither the one that is lower than 400 cubic meters.

The dimensions and surface area of the alternative pond are presented in Table 4.2. The proposed water harvesting pond has a trapezoid shape whereby the top width of the pond is not equal to the bottom width. So the farmer in this case has to sacrifice approximately a maximum of 5% area of his cropland for the construction of the pond. There are basic factors required to estimate the suitable pond size for supplemental irrigation. Such factors may include irrigation water demand, size of the irrigation land, type of crop and the financial ability of the farmer.

Excavation of the water pond may be either by an excavator or bulldozer but this mostly applies to large scale farming where the pond size is relatively large. However for small-scale farming suitable for the land ownership scale in Uganda, excavation is commonly done using simple hand tools like hoes and or oxen driven ploughs. Labor is mostly supplied by family members, so there is no need to hire tractors for the excavation processes except if it's a relatively large pond.



The trapezoidal shaped water pond should be constructed at a point within the farm boundaries where it can collect the maximum amounts of runoff and also allow for the escape of the excess storage from the pond. The pond should be established with an embankment of about 1m away from all the edges of the pond and then an outlet is created at the lowest side of the embankment to allow spillage of excess runoff.

It was reported by Molle, et al. (2012) and Pandey, et al. (2013) that up to 50% of the water losses in the irrigation systems is attributed to evaporation. Seepage losses in water storage ponds have been reported by different authors around the globe. It was estimated to reach 41% of the total water losses in the irrigation system as mentioned by Sur, et al. (1999). Other studies have reported higher seepage losses up-to 89% of the total water loss in earthen ponds from seepage alone. This poses a great challenge to solve the problem of seepage losses in irrigation agriculture.

In this study, the proposed supplemental irrigation scheme is adopted and modified from a recent study conducted by Pandey (2013) as shown in Figure 4.11. The modifications are mainly related to the pond structure whereby the proposed storage system in this study is composed of sedimentation or settlement pond where runoff settles before it is directed to the main storage pond through an underground pipe. Secondly the pond is also lined with polyvinyl chloride (PVC) liner to prevent the seepage losses and at the same time covered with an aquatic plant to prevent mosquito breeding and at some extent to reduce evaporation losses of collected water.

Figure 4.11 illustrates the whole concept of supplemental irrigation proposed in this study. As a rainfall event occurs, water falls on the soil surface and it starts flowing downstream. Some of this water infiltrates to the deeper soil layers while some of it evaporates to the atmosphere. Meanwhile a bigger percentage flows as surface runoff to the lower areas of the catchment by the effect of gravity. This runoff is concentrated at a certain point and directed into a water storage pond with the aid of gullies, furrows or rills. The storage medium is composed of the sedimentation pond, an underground pipe and a bigger water storage pond with a spill away channel in case of excessive storage.

The sedimentation pond is mainly for the settling of sand, trash and other suspended materials in the runoff. Between the sedimentation and the storage pond is a small inlet pipe that allows water to enter into the storage pond. On one side of the pipe (at the side of the sedimentation pond) is a metallic wire mesh that prevents other trash from entering the storage pond. The bigger storage pond is well lined with a Polyvinyl chloride (PVC) to prevent the heavy losses of water through seepage. More specifications about the PVC liner are given in Table 4.2.

Furthermore the extended part of the liner on the top sides of the pond is covered with a heap of soil to prevent direct contact of the liner with radiation from the sun. The pond is also covered with

a water fern (Azolla) which makes the pond more environmentally friendly and financially economical. More details about the aquatic plant and why it is used in this study are given in the next sections in this chapter.

So after the water has been successfully collected in the pond which in most cases is situated at a lower point of the cultivated land, there is a need to lift/pump water to the crops. There are different alternatives of water lifting from the pond to the cropped area which are examined in this study such as the traditional rope and bucket system, the treadle pump, diesel pump and the solar pumping engine. These water lifting techniques are all discussed in details in next sections of this chapter. Since the water surface is covered with Azolla plant, the pipe for pumping water should be submerged at least at 1m depth of water which on the other hand will increase the static lift to pump the water. The storage pond is established with a total depth of 2m to reduce the pumping costs and also to avoid the uplift of the pvc lining by the groundwater. More design parameters for rainwater harvesting ponds can be accessed from (Pingale, Khare, Sharma, & Mahesh, 2009) (Pandey, Zaag, & Soupir, 2013).

#### Proposed supplemental Irrigation Scheme

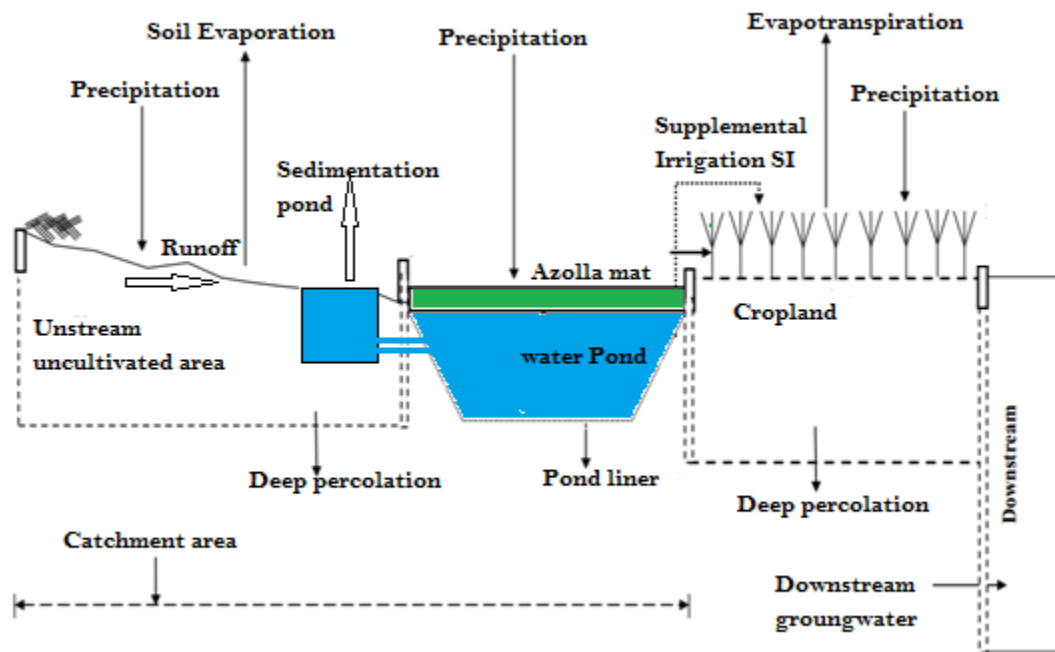

**Figure 4.11** Supplemental Irrigation System adopted and modified from Pandey (2013)

This research study develops a sustainable, economical supplemental irrigation scheme and as observed in Figure 4.12, the scheme was under construction in the study area. The system is suitable for the land use in the study area in addition to other areas with similar climatic conditions

in Africa facing the same water shortage problem in the field of agriculture. This system can easily be adopted and afforded by an average farmer. The simply designed pond is developed to collect water that can serve and feed an average cultivated area of about 3 acres of land for supplemental irrigation. The pond can be designed with varying capacities to store water. Several simulations were conducted using Aquacrop to test for optimization among the four alternative storage pond volumes i.e. 1000, 800, 600 and 400 m<sup>3</sup>.

#### Proposed Scheme under construction in the study area



**Figure 4.12** Runoff harvesting pond under construction in the study area

#### 4.11: Advantages and Limitations for using Pond liners

Pond liners are impermeable geo-membranes which are used for the purposes of water retention. They are made of different types such as Polyvinyl chloride (PVC), High density polyethylene (HDPE), Ethylene propylene diene terpolymer (EPDM) and so many other types. Each type is more suitable for a specific purpose and areas of application.

### Advantages of Pond liners

- The most considerate advantage of using a pond liner is its low cost compared to other options like building concrete pond walls to avoid seepage of water. Pond liners can be relatively afforded by any small scale farmer in the area.
- They have no permanent effect to the environment since they can only be used for a certain period of time and then they can be replaced or disposed off.

### Limitations

- Low Durability of the plastic pond liners compared to concrete built ponds.
- Plastic liners can be easily damaged during maintenance procedures like in removing silt during the off-rainy season.
- Requires some skill of application i.e. the process of laying the liner into the pond needs a highly qualified personnel to do the needful, the process of binding the layers and laying it in the pond cannot be accomplished by a local unskilled farmer.

### 4.12: Using Azolla

Azolla is a floating water fern which grows in a symbiotic association with *Anabaena azollae*, a heterocystous cyanobacteria. The water fern is considered as the world's smallest macrophyte plant with a very fast growth cycle. The plant can grow and cover double its area of coverage on water with in 5 to 10 days (Kollah, Patra, & Mohanty, 2016). The provision of the natural nitrogen from the atmosphere by the cyanobacteria in its leaf cavities makes azolla freely to grow without soil on freshwater surfaces relying on the vast amounts of fixed nitrogen by the bacteria. The surface aquatic plant actually improves the quality of the stored water by adding atmospheric nitrogen into the water which will then be supplied to the crops.

In this study, azolla is proposed as water cover primarily to control mosquito breeding on the open water ponds. The water fern has mostly been utilized as a green manure for soil improvement. Different species of Azolla like *A. piñata*, *A. Africana* and *A. filiculoides* have been used as nitrogen sources in farm lands for so many years as alternative strategies to improve crop production (Van Hove & Lejeune, 2002), as illustrated in Figure 4.13

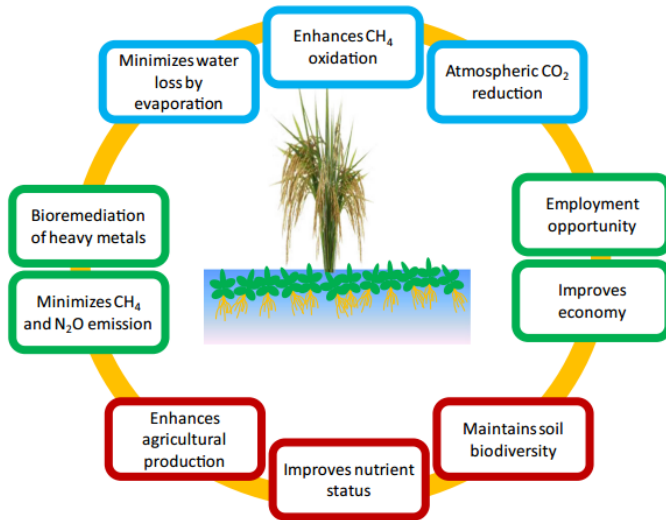

**Figure 4.13** The enormous benefits of Azolla

Despite the fact that a lot of research has been done in the previous year's using Azolla for soil and agricultural management, there is a big gap on its application in Africa in other areas such as water harvesting, bioremediation, animal feeding, gas mitigation etc. Azolla has a great role in controlling mosquito breeding over water surfaces (Subedi & Shrestha, 2015). A lot of different researchers have reported the potential significance of Azolla in controlling mosquito breeding on surface water bodies (Van Hove & Lejeune, 2002) (Imbahale, Mweresa, Takken, & Mukabana, 2011) (McLaughlin , Hiba , G, & D, 2000) (Mahapatra & Sharma, 1989). Azolla mat suppresses mosquito breeding by inhibiting ovi-positioning of the female mosquitoes and also acting as a physical barrier for mosquitoes to lay their eggs on the surface of water as shown in Figure 4.14. Most of the authors argue the effectiveness of the aquatic plant is higher with 80% of the surface of the water covered (Imbahale, Mweresa, Takken, & Mukabana, 2011) (Van Hove & Lejeune, 2002).



**Figure 4.14** Azolla mat on a water surface for animal feeds

Due to its fast and short growth cycle of about 5 days, Azolla has also been used for feeding domesticated animals like pigs, chicken, ducks, fish etc. It can replace conventional chicken meals with 5-15% Azolla feeds can significantly lead to a similar growth and body weight increase like the mustard oil cake meal in broilers (Ashraf, Matto, Ganai, Reshi, & Sheikh, 2015) (Kollah, Patra, & Mohanty, 2016). So in this study, it implies that Azolla can still be harvested occasionally and fed to the livestock since it can multiply in just 5 days, this can save the farmer the additional costs of animal feeds.

Due to the already mentioned environmental and economic benefits of Azolla plants, this qualifies it to be the best alternative for covering the water ponds. Other options to cover the ponds can be the iron sheets, straw shades, or a plastic top cover. However all these alternatives have mega limitations compared to azolla, it may be in terms of costs like the costly iron sheets making the system more expensive, or in terms of sustainability and durability like the temporary straw shades. Azolla provides multi benefits as it can be used for several other purposes rather than control of mosquitoes. However, in spite of all mentioned benefits of Azolla, the plant poses also an environmental threat to the natural water bodies. If not handled and controlled well, azollae can escape and establish on surfaces of other natural bodies which can be a very big problem in water navigation and fishing activities.

#### 4.13: **Ways of Water uplifting from the Pond**

There are four main ways of how farmers can convey irrigation water to their crop lands from the water harvesting ponds.

##### **1. Rope and Bucket method**

Local farmers in Uganda mostly use buckets and other small containers to lift water from their water harvesting facilities and use surface irrigation to water crops as shown in Figure 4.15. This system is commonly used for smaller cropping areas of maximum an acre of cultivatable land (horticulture). It's also mostly used in case of vegetable cropping because of their ease in irrigation water application since their canopy does not grow that tall.



**Figure 4.15** Rope and Bucket system (Shiksha, 2017)

#### Advantages

- ✓ Suitable for smaller scale farming
- ✓ Does not need capital investments
- ✓ Requires only man power which in most cases is provided by the family members

#### Disadvantages

- Not applicable to large scale farming
- Irrigation time is longer and exhaustive
- Requires human labor to do the work i.e. workers have to be paid for each cubic meter of water withdrawn.
- Not efficient in terms of application time and water productivity

## 2. Pedal or Treadle pumps

These pumps were first used in Bangladesh in the late 19<sup>th</sup> century and then they spread to different parts of the world most especially to Asia and Africa. Pedal pumps In Uganda commonly referred to as the “money maker” since they have been made using the local technology that only uses manual power to induce suction power to pump water through a pipe from the water pond to the crop land. It can extend to more than 50m distance away from the water pond. It uses a pedal system which can be continuously pressed by one operator or a farmer himself using feet and then water is delivered to the crops through a pipe as shown in Figure 4.16.



**Figure 4.16** Operation of a Treadle pump

#### Advantages

- ✓ No fuel costs
- ✓ Cheap to purchase
- ✓ Easily operated and needs less maintenance

#### Disadvantages

- Pumps water at a relatively smaller distance
- It's not an automated system
- Can only be applied for a small scale farming area

### 3. Diesel water pumps

These are the normal diesel water pumps used to pump water at any distance within the farm's enclosure. They can be of different pumping capacities from small to bigger pumps which can extend the water to very far distances.

#### Advantages of Fuel water pumps

- ✓ They are easily accessible from anywhere in shops and energy companies
- ✓ They are easily operated, do not need skilled or trained personnel
- ✓ They are available with varying pumping capacities from small-scale farms to large commercial farms

#### Disadvantages

- Diesel or petro pumps consume fossil fuels i.e. not a sustainable energy resource
- They are very expensive
- Require periodic maintenance



#### 4. Solar Powered pump

Solar energy water pumps have been rapidly introduced on Indian farms and they have proved to be the energy drivers on most of the agricultural farms in almost all the countries. They are more used in arid and semi-arid areas where solar radiation is abundant. In Uganda, most of the agricultural companies and farms are more focused into energy saving technologies to maximize profits.

##### Advantages

- ✓ Uses solar energy i.e. no fuel costs
- ✓ Has higher efficiency
- ✓ Ideal for small scale farming
- ✓ Environmentally- friendly technology

##### Disadvantages

- It's a new technology which needs further enhancement
- Mostly applicable for small-scale holdings

### 4.14: Costs related to the development of the Supplemental Irrigation Scheme

#### 4.14:1: Capital Costs

**Table 4.2** gives an account of the costs of the construction of the pond and the pond liner (PVC) that is used in this study for all the four different pond capacities. All these costs are calculated based on a one hectare piece of land for crop cultivation and irrigation. The costs are presents in (UGX) which means the **Ugandan Currency. \$1 US is equivalent to 3550 UGX.**

**Table 4.2** Pond Dimensions and Construction costs

Pond Volume (m <sup>3</sup> )	Pond Dimensions (m)	Pond Liner Dimensions (m)	Unit Cost of Pond Liner (UGX)	Total Cost of Pond Liner (UGX)	Total Construction Costs (UGX)	Total Construction Costs (\$ US)
<b>400</b>	10 x 10 x 2	16 x 16	10,000	2,560,000	4,040,000	1,138
<b>600</b>	20 x 15 x 2	26 x 21	10,000	5,460,000	7,655,000	2,156
<b>800</b>	20 x 20 x 2	26 x 26	10,000	6,760,000	9,720,000	2,738
<b>1000</b>	25 x 20 x 2	31 x 26	10,000	8,060,000	11,835,000	3,334

Before lining the pond with the polyvinyl chloride membrane liner (pvc), the pond walls and sides have to be coated with sand to create a smooth surface for the easy lining of the pond and also to prevent the damaging of the plastic liner by sharp stones or plant roots. By doing this, it helps to

reduce the costs of the pvc lining by only applying one layer. Annual Unit Operational and other related Costs

All the necessary costs for the four different water lifting systems which are analyzed in this study have been thoroughly explained below and their costs have been put into consideration for the development of the cost benefit analysis. The system is developed to be used for supplemental irrigation during the most critical water sensitive stages during the growth cycle of a maize crop, the research focuses on irrigation during the flowering period which takes a period of 14 days i.e. 14 days of irrigation are required in a growing season of 120 days (Maize growth cycle)

### 1. The Rope and Bucket application

As elaborated earlier, this is a traditional method that has been used for centuries to irrigate small plots of horticultural lands in Uganda, the major advantage associated with this method is its low capital investment in that it requires no great deal of tools for its application, just a mere rope and a bucket with a few workers. On the other hand, the same method has got major constraints related to the high human energy demands and the smaller flow rate. This technique can allow for an application of about 2 m<sup>3</sup> of water per hour with an average depth of 2m under the ground. The following features describe the financial aspects of this particular system. The related Annual costs include:

- The bucket method can deliver 2 m<sup>3</sup> of water from the pond each day by one person
- 24 Workers required to do the job in 14 days at **UGX 15,000** each per day
- Total labor costs **UGX 5,040,000** for the irrigation period
- Purchasing price for buckets Annually at **UGX 120,000** life time of one year
- Annual Depreciation of **UGX 28,000**

### 2. The treadle pump

Treadle pumps are mostly designed using the locally available tools. Originated from Bangladesh in the late 1980's, Treadle pumps have spread to all developing countries due their low capital costs and the need to expand irrigable land aiming for more produce. They have a capacity that can extend 5-7 m<sup>3</sup> of water per hour. It can only be operated using two workers, one for the pumping and the other for directing the flowing water in the pipe to different parts of the crop land along its reaches. Related Annual costs include:

- The treadle pump used in this study can deliver 6 m<sup>3</sup> of water per hour
- 3 workers can be employed to do the job for 14 days at UGX 15,000 @per day
- Total labor costs for operating the system for the whole irrigation period **UGX 630,000**

- Purchasing price for the treadle pump and its delivery horse is **UGX 720,500** with an expected lifetime of **6 years**
- Purchasing spare parts, repair and maintenance of the pond and pump estimated at **UGX 100,000** annually
- Annual depreciation of **UGX 1,982**

### 3. Motorized Pump

Motorized water pumps could be of either diesel fuel or gasoline with a range of capacities from 2-5 horsepower. They allow for greater expansion of irrigable land and offer a possibility to grow other crops, however their high costs related to purchasing, operation and maintenance costs are so high. Motor water pumps have higher flow rates most especially if the water depth is not very deep, when the water source is on surface i.e. not more than 2 m depth, the capacity can even reach 15 m<sup>3</sup> per hour. The related Annual costs include:

- The motorized pump used has a capacity of 15 m<sup>3</sup>/ hour
- 1 worker employed for 14 days at UGX 10,000 per day, Total Cost of **UGX 140,000**
- Purchasing price is **UGX 2,090,000** with a life time of **10 years**
- Spare parts, repair and maintenance of the pond and the Lubrication oil costs of the pump at **UGX 200,000**
- Fuel consumption of 0.5L/hour for 5 hours per day, Total fuel costs for the whole year at **UGX 112,000**
- Annual Depreciation of **UGX 886**

### 4. Solar powered pump

Solar powered water pumps have been rapidly introduced on Indian farms and they have proved to be the energy drivers on most of the agricultural farms in almost all the countries. They are more used in arid and semi-arid areas where solar radiation is abundant. In Uganda, most of the agricultural companies and farms are more focused into energy saving technologies to maximize profits, its related costs include:

- The solar powered pump used in the study has a capacity of 8 m<sup>3</sup>/ hour
- 1 worker employed for 14 days at UGX 10,000 per day, Total Cost of **UGX 140,000**
- Purchasing price is **UGX 5,060,000** with a life time of **20 years**
- Spare parts, repair and maintenance of the pond and the pump at **UGX 120,000**
- Annual depreciation of **UGX 2,915**

All the above capital, maintenance and operational costs for the water lifting techniques and maintenance of the pond are summarized in Table 4.3.

**Table 4.3** Summarized Costs for the water lifting Techniques for supplemental Irrigation

Water Lifting Tech	Purchasing Price (UGX)	Annual Operation costs of the pump and maintenance of pond (UGX)	Annual Depreciation UGX	Flow rate (m <sup>3</sup> /h)	Life Time in years
<b>Rope and Bucket</b>	120,000	5,040,000	28,000	2	1
<b>Treadle Pump</b>	720,500	730,000	1,982	6	6
<b>Solar Pump</b>	5,060,000	260,000	886	8	10
<b>Diesel Pump</b>	2,090,000	452,000	2,915	15	20

## Chapter 5. **Simulation Water Model**

The study employed FAO's water productivity model - Aquacrop to simulate maize crop production under the conditions of rain-fed and supplemental irrigation. The model is used to address the issues of crop-water use efficiency, food security and also assess the effect of the environment and field management practices on crop production. Simulations are made after a process of data collection from the study area which included data for different climatic parameters (temperature, rainfall, etc), soil sample analysis and conclusions made through observation during the study period (Vanuytrecht, et al., 2014).

Simulation of maize yields from the model under different irrigation levels are studied and analyzed to develop a cost benefit analysis. The results from the cost benefit are used to recommend the best irrigation system suitable for the study area. A supplemental irrigation system is established with a simple designed water collecting and storage facility to accommodate surface runoff for the periods of wet or rainy seasons.

### 5.1: **Description of Aquacrop - Crop water Model**

Aquacrop is a climatic model developed by FAO to assess the crop yield response to soil water in the plant root zone. The model has been modified into several versions of which they serve the same purpose however with quite a few differences in inputs and outputs. Since so many years back, research related to field conditions has always been conducted in the field through conducting field experiments which could last for years and become expensive to sustain in the long run.

Due to the current issues of water scarcity, Aquacrop can be used to generate results and develop recommendations to improve water use efficiency in agricultural food production Figure 5.1. In just a short time, simulations can be run and valid recommendations are formulated according to the inputs provide for the system. The model performs simulations using sophisticated mathematical models but however it presents its results in simplified and real life case scenarios.

## 5.2: Aquacrop Model Framework

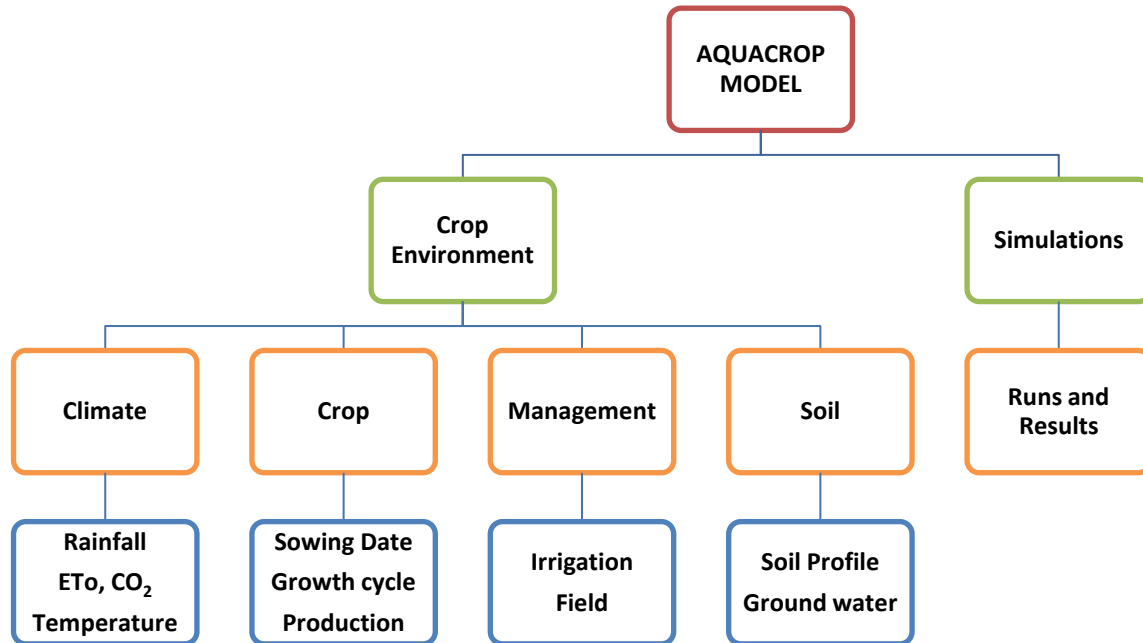

**Figure 5.1** Shows the framework of the aquacrop model adopted from (FAO, Aquacrop, 2016)

The model functions by relating the interaction between the crop parameters, climatic conditions and the soil properties in addition to the practices of field management. It uses relatively small number of parameters and attempts to balance simplicity, accuracy and robustness in its results. It only uses general data that can easily be attained by the researcher so that it generates accurate information about crop production and soil water balance.

## 5.3: Model Applications

The FOA model was first developed in 2009 and so far some other versions have also been developed to enrich its performance. However the model can be used for multi purposes as outline below.

- Understanding field crop water responses
- Calculating yield gap analysis i.e. Actual yield and the potential yield of the crop
- Optimizing Evapotranspiration water productivity through making modifications in sowing dates, changing crop cultivars, introducing deficit irrigation etc.
- Designing irrigation schedules
- Calculating the historical and future effects of climate change on food production
- Formulating scenarios and recommendation for policy makers.

The FAO developed model does not use Leaf Area index (LAI) for predicting crop growth as it is with most of other crop water models but instead it uses the Green canopy cover i.e.

**Green Canopy Cover (CC)** is defined as the percentage of ground covered by a vertical projection of the outermost perimeter of the natural spread of foliage of plants.

$$\text{CC} = \frac{\text{Soil surface covered by the Green canopy.}}{\text{Unit ground surface Area}} \quad (8)$$

### Steps in Crop Yield Simulation

There are four specific different stages that the plant goes through before reaching full maturity and the model simulates all the changes through these four stages.

Stage 1 - Crop development Stage

Stage 2 - Crop Transpiration

Stage 3 - Biomass production

Stage 4 – Yield formation

### Crop Physiological Concept

**Figure 5.2** gives a summarized view of the whole concept of the physiological processes that take place in the crop's life cycle. Aquacrop calculates the final crop yield by putting into consideration all the above processes shown in **Figure 5.2**. It shows the stages of a crop's life cycle and how each stage is affected by the environmental factors. There are two most important types of crop stresses which are also well represented in this same figure i.e. water stress and temperature stress.

Dotted arrows represent different processes and how they interact with each other. Arrows from (a - e) indicate how these processes are affected by water stress. Direction (a) shows how water stress affects canopy expansion (CC) during the initial stages of crop growth while (b) shows how water stress can also increase canopy expansion in the later stages of the crop's life cycle, (c) indicates the possibility of extreme water stress to reduce root expansion and root depth (Zr) during the vegetative growth stage of the crop, (d) shows how the severe effects of water stress can reduce the rate of transpiration and stomata opening and (e) shows how harvest index (HI) can be reduced because of the effects of water stress (Vanuytrecht, et al., 2014).

Indications (f) and (g) represent the effect of temperature stress on the crop. (f) shows low air temperature affects the biomass water productivity (WP\*) and (g) indicates the effect of both high and low temperatures inhibit the process of pollination and eventually reduce the Harvest Index



(HI). The relationship between rainfall, runoff and irrigation stems on the rainfall characteristics such as the quantity, intensity and patterns of distribution. Furthermore collected runoff may also depend on the soil surface characteristics, size of the catchment area, and geomorphologic characteristics.

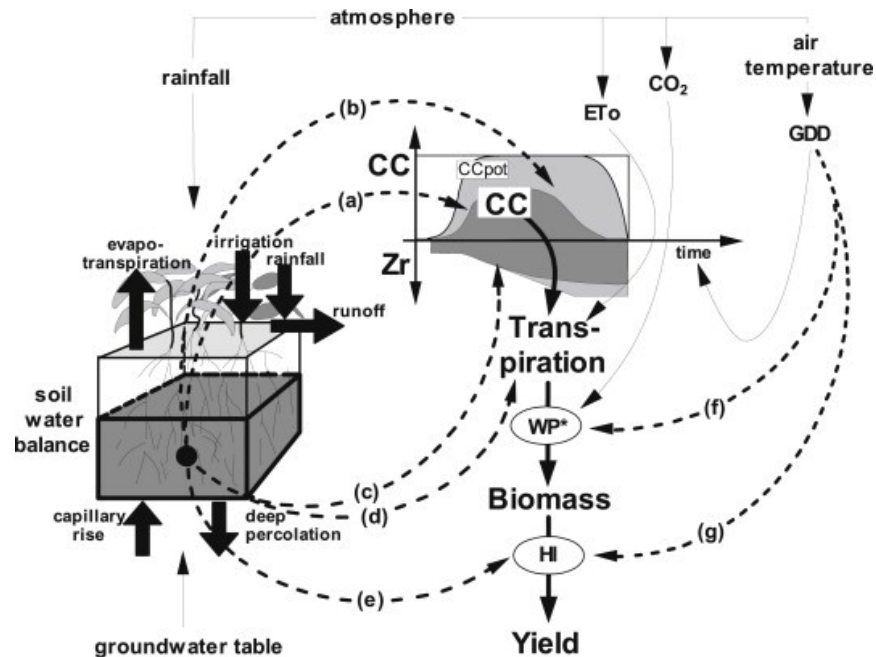

**Figure 5.2** Shows crop physiological Concept (Vanuytrecht, et al., 2014)

#### 5.4: Simulation of Soil water Balance

The model simulates the soil water balance by considering all the possible soil moisture sources such as rainfall, capillary rise and/or irrigation as well as all the possible ways of losing the moisture from the soil. These include transpiration, evaporation, runoff and deep percolation as shown in Figure 5.3. In presence of more rainfall or irrigation water, the soil water level can go above the field capacity (the amount of water remaining in the soil root zone after 2 to 3 days of a rain event and after free drainage had stopped) hence resulting in deep percolation and sometimes flooding in case of the presence of a soil hard pan. This literary means that the soil has excessive moisture in the crop root zone and this is not good for some crops. In the case of low rainfall or without irrigation water in the soil, the water level in the root zone drops below the field capacity and eventually the moisture level reaches the permanent wilting point (PWP). This drives the crop into water stress conditions.

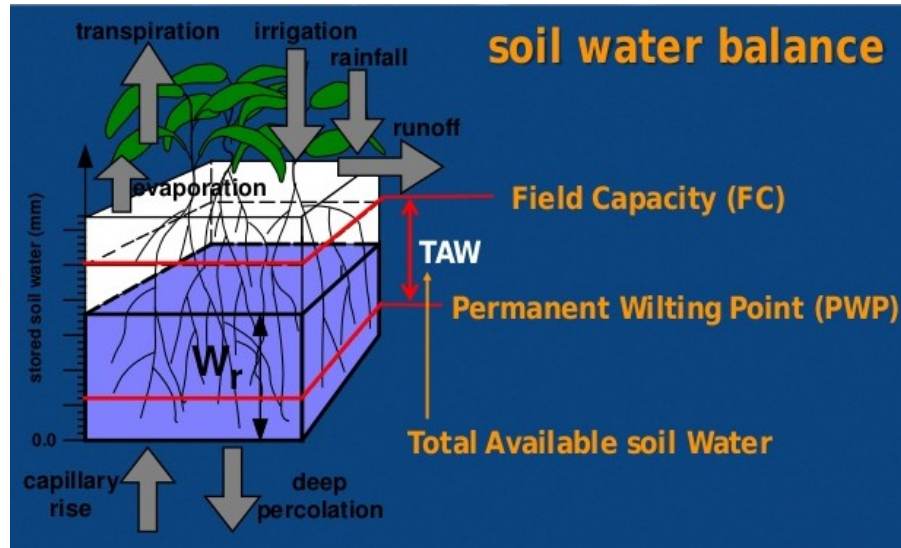

**Figure 5.3** Soil Water Balance (FAO, Aquacrop, 2016)

#### 5.4:1: **Water stress related to yield formation**

Water stress in crop production can affect crop yields in two ways; either with an increase in the harvesting index above the reference harvesting index or a decrease in the harvesting index below the reference harvesting index. The positive yield or an increase in harvesting index from the base reference harvest index can only occur when the water stress affecting leaf expansion happens during the vegetative growth stage and after the reproduction phase of the crop.

If water stress hits during the vegetative growth, instead of the plant using the stored carbohydrates for leaf growth and expansion, they are then channeled for grain formation and filling and this eventually leads to an increase in harvest index (HI). This is elaborated in Figure 5.4 with the upward adjustment of the harvest index (HI adj).

The negative adjustment or decrease in harvesting index happens when water stress affects the stomata closure of leaves. This means that less carbon dioxide will be used, less carbohydrate will be produced and finally low yields will be produced for that season, it's the downward adjustment of the Harvest index.

Both scenarios (upward or downward HI adjustments) depend on a couple of factors i.e. the type of the crop, magnitude of the stress parameter and also some environmental conditions.

## Effect of water stress on the Harvest index of the Crop

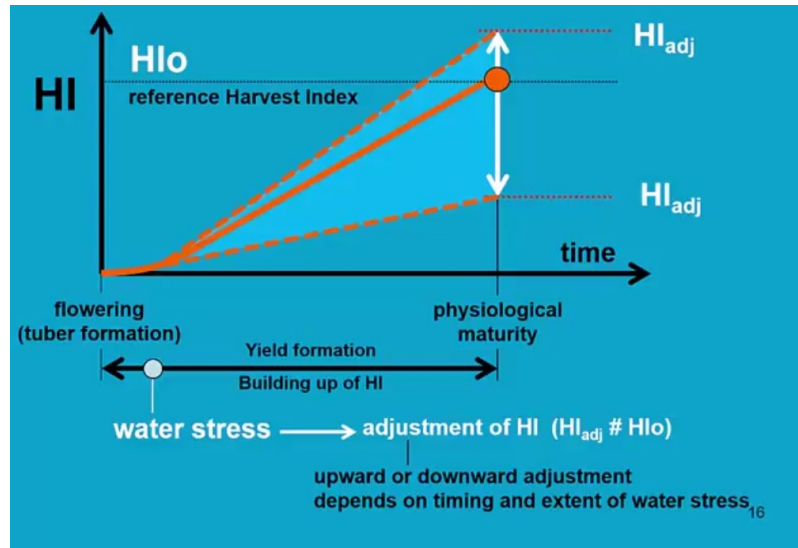

**Figure 5.4** Effect of water stress on harvests (FAO, Aquacrop, 2016)

There are three theoretical water stress levels (thresholds) that the plant passes through before it dies off at the wilting point.

- Upper Threshold – Water stress affecting leaf expansion**  
 This theoretical line is just below the Field capacity water level of the soil. In the Aquacrop model, when the water content in the soil drops below this line, leaf expansion of the growing crop starts to deteriorate. However if the magnitude of this kind of stress is not that big, it can lead to an increase in the harvesting index hence more yields formed
- Middle Threshold – Water Stress affecting Stomata closure**  
 This theoretical line represents the start of stomata closure; it's represented by a transpiration factor  $K_s$ . It is the second line below the upper threshold line. When the water level falls below this line, the plant stomata starts to close which eventually reduces the transpiration process of the whole crop.  $K_s$  value reduces and gets lower than 1 when the water levels drop below this line and when it reaches the Wilting point,  $K_s$  becomes zero.
- Lower Threshold - Water stress triggering canopy senescence**  
 This line represents canopy senescence, below this level, the crop starts to die.

### 5.4:2: Water stress effect on flowering

In a normal scenario, all plants produce lots of flowers during the flowering period, actually most plants produce excess of flowers; however the most important point here is the pollination of all those flowers made by the plants. If at any point during the flowering period there is scarcity of water in the root zone, these flowers will not have a chance to mature to a point of being

pollinated due to the fact that there is not enough water to facilitate the whole process of flower formation. This is represented by a theoretical threshold termed as the threshold for root zone depletion. It means that if the water level in the soil drops below this theoretical line, there will be a failure in pollination of the flowers.

## 5.5: Modeling for Irrigation Management

In the Aquacrop model, there are two modes of availing water to the crops (Vanuytrecht, et al., 2014)

- a) Rain-fed Cropping: Aquacrop can simulate crop production and development using the rainfall data provided by the user in absence of any irrigation events. It can model the whole canopy development depending only on the rainfall events that were provided in the climatic file.
- b) Modeling with Irrigation during the season:  
Irrigation in the model can be simulated under two circumstances, the two strategies are aimed at increasing the crop water efficiency i.e. increasing the amounts of yields at the end of the growing season while using less amounts of irrigation water.
  - i. Net irrigation water requirement – this kind of irrigation is simulated using a threshold (Inet) known as the allowable root zone depletion. This threshold can either be expressed as a fraction or a percentage of Readily Available Water (RAW). In case of no rainfall events for a specific period of time and the water level in the root zone drops below a certain level, small amount of water is applied to keep the water content in the root zone to keep water at a specific level. At field capacity RAW is equal to 0% and it's 100% at threshold at stomata closure.
  - ii. Generation of an Irrigation schedule - when designing an irrigation schedule there is a need to specify a specific date of when to supply the irrigation water to the crops, the water quality should also be updated i.e. the salt content of the water and then the net amount of water which should be applied i.e. the amount of water that infiltrates in the soil.

### Crop growth parameters

The maize crop reaches maturity stage at 120 days; this whole period can be divided into four different stages from the time of planting till harvesting time. Maize is planted by sowing in rows either 1 plant /hill or 2 plants/hill depending on the variety of the maize crop and the purpose of the crop whether it's maize for grain yield, sweet maize for salads or maize for livestock feeding. With row spacing of 75cm, the space between

hills at 30cm, another option which is characterized by 2 plants /hill has row spacing of 75cm and space between hills of about 60cm. The maize planting density is 44,444plants /ha (4.4 plants/m<sup>2</sup>).

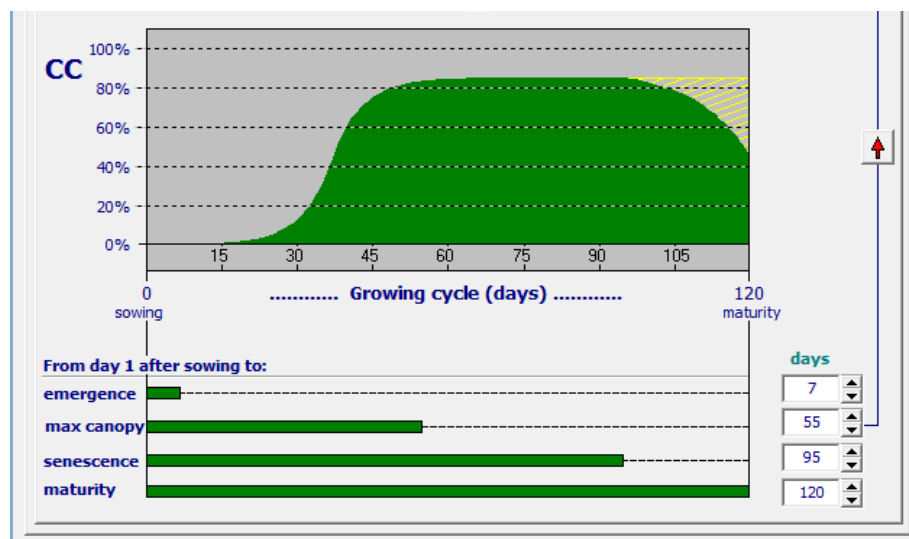

**Figure 5.5** the Maize Growth cycle (FAO, Aquacrop, 2016)

The growing cycle is divided into four stages Figure 5.5:

- Emergency stage – 7days from Day After Planting (DAP)
- Maximum Canopy – 55 days from DAP
- Senescence stage – 95days from DAP
- Maturity stage - 120 days

The flowering period takes 13 days from 68 – 81 days after planting; the crop reaches a maximum rooting depth at 55 days after planting which is the same time it reaches maximum canopy development.

## 5.6: Crop characteristics

Maize is a cereal grain producing crop which is the staple food for all the East African nations including Uganda, Kenya, Tanzania, Burundi and Rwanda. The model can either simulate crop development using Growing degree days (GDD) or calendar days which are directly linked to the growing cycle. During the simulations the later criteria was used due to the fact that sowing of maize crops in the Eastern region of Uganda is dependent on the planting date which is in most cases in the last ten days of March.

In rare cases farmers also initiate sowing of the maize crop in the last days of March after receiving like some two events of rainfall. This has only been practiced when they missed the

planting dates because of the excessive dryness in the soil root zone. In another scenario, some farmers also do what is known as the dry planting. Dry planting is a practice commonly done with farmers in semi-arid regions whereby they initiate sowing of seeds in the soil when the soil is still dry without rainfall. So when the rainfall comes later after some days, seeds will start to germinate.

Aquacrop uses simple mathematical calculations depending on the input data provided by the user to simulate crop development. The model sets default values for the available soil moisture in the root zone for the crop to start germinating. This is similar to the temperature requirements for the crop development; Aquacrop sets a default value for the base temperature of 10°C and an upper temperature of 30°C for the whole cycle of maize development. These two figures represent the lowest temperature a maize crop can withstand and also the highest temperature that the plant can bear respectively. Outside this temperature range, the crop starts to deteriorate which slows down the development process. This is called the temperature stress effects.

**Germination** – since the maize seeds are directly planted into the soil, the initial canopy cover is obviously very small of about 0.22% compared to other crops which are planted by transplanting. This means that maize crop lands experience high levels of water evaporation from the start of the season if no field management practices have been put into place such as mulching. The maximum canopy cover (CC) a maize plantation can reach is about 85% CC which it attains at 55 days after planting (DAP).

Canopy cover is a conservative crop parameter since it depends on the sowing patterns and the growth habits of the crop, for example, the previously mentioned 85% canopy cover for maize crop which is reached after 55 days from the sowing date, applies when the seeds are sown at 2 plants /hill with a distance of 75cm between rows and 60 cm between the hills within a row. With such sowing standards, the model calculates the plant density of 4.4plants/ m<sup>2</sup> which is equivalent to 44,444plants/ha.

During the model simulations, Aquacrop calculates the seedling canopy size in the initial stages of growth of about 5cm<sup>2</sup>/maize seedling. The low maximum canopy cover is attributed not only due to the planting patterns but also the vegetative structure and the size and shape of the crop leaves. The fact that maize has linear leaves, they do have a smaller surface area cover compared to plants like the leguminous crops with broad leaves.

Starting from sowing, a maize crop reaches emergence stage after 7 days and then it takes 48 days from emergency to the maximum canopy stage. From the maximum canopy stage, it takes maize crop 40 days to reach senescence stage shown in Figure 5.6. The rest of the days are just for maturing the grains till the end of the season at 120 days after planting. So in summary a

maize crop takes 7 days after sowing till emergency stage, 55 days from sowing till maximum canopy stage, 95 days from sowing to reach the senescence stage and finally 120 days to reach maturity.

Considering the rooting depth, maize is a medium rooted crop with a prop root system. It reaches its maximum rooting depth at the same time the crop attains the maximum canopy. The maximum rooting depth is 1m and the model goes ahead to calculate the average root zone expansion of the crop which is 1.5cm/day.

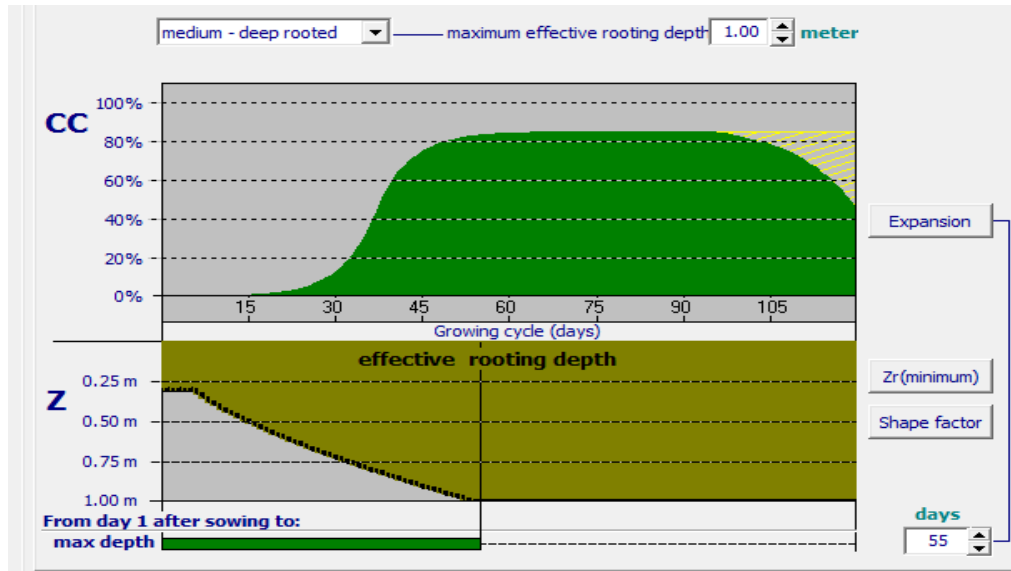

**Figure 5.6** Effective Rooting depth and Maximum Maize CC reference (FAO, Aquacrop, 2016)

### 5.7: The climatic parameters

For a better performance and accuracy of the model, Aquacrop requires daily rainfall data, daily minimum and maximum temperature data, daily minimum and maximum relative Humidity, wind speed, carbon dioxide concentration and radiation data for the study area for all the study period. Even though there was full access to the daily rainfall data and temperature data, some other parameters had missing data for quite a longer period. This prompted to go to the local study area’s weather station in Soroti to inquire whether they also had the same data records as that of the National Meteorological center. With no objections, their records matched with the National data records I had obtained earlier.

The atmospheric Carbon dioxide concentration used in this research to simulate the carbon dioxide requirement of maize was a default value from the Aquacrop model from Muana Loa between the years 1902 and 2099.

Evapotranspiration - Before simulating with Aquacrop, the model requires the user to provide all the necessary data needed to calculate the reference evapotranspiration (ET<sub>o</sub>). The user needs to provide data for the study area which includes the minimum and maximum relative humidity, wind speed and the sunshine or radiation data for the study period. Unfortunately there was limited data in all the climatic parameters needed to calculate ET<sub>o</sub>.

For this reason therefore, ET<sub>o</sub> is calculated using the **Blaney – Criddle Method** which was explained in Chapter one earlier. It's a theoretical method that only uses the temperature data to estimate ET<sub>o</sub>. It's a simple method that is more recommended to be used in areas with high relative humidity, non windy and cloudy conditions.

So many factors influence ET<sub>o</sub> for example the prevailing rates of evaporation and transpiration. Soil evaporation is mostly influenced by the solar radiation that reaches the top soil surface from the sun. The rate of evaporation on the cropped land is highest at the time of sowing when the canopy cover is zero. Water evaporating from the cropped land decreases as the crop growth increases. The more vegetative growth the plant attains, the less is the rate of soil evaporation from the soil surface due to the larger coverage of the soil surface by the plant leaves and branches.

Crop Transpiration has an inverse relationship with soil evaporation in that when the evaporation is highest, crop transpiration can either be zero or very low. However as the evaporation rate decreases along the growth curve, transpiration starts to increase till it reaches the maximum at the maximum canopy cover and the maximum rooting depth.

## 5.8: Model Results

This section gives a detailed account of the results from the model simulation and their discussion.

### 5.8.1: Rain-fed Production Analysis

The initial simulations runs of the model were based on the existing agricultural system in the study area which is rain-fed agriculture without considering any kind of supplemental irrigation. Crop yields are simulated depending on the soil characteristics, field practices and rainfall. A period of ten years from 2003 – 2012 is simulated and the simulated crop yields are presented

Results from **Error! Not a valid bookmark self-reference.** show that there is no clear trend of either an increase or decrease in crop yields since 2003 and 2012. However the yields only increased or decreased depending on the amount of rainfall received during the particular season. It can be observed from the table that an increase in yields is influenced by a higher amount of rainfall received in the growing season. It's clear from the table that water productivity



ET and Transpiration (Tr) only increased with an increase in seasonal rainfall too. However the reference evapotranspiration (ETo) and the potential biomass yield was almost the same for all the seasons since they're localized parameters which depends on the average weather conditions and soil characteristics. The Actual yield (Green Biomass yield) and the Dry yield which is the grain yield for each season varied due the fact that it is dependent on rainfall and other factors that influence production.

Table 5.1. ETo refers to Reference Evapotranspiration in mm. Tr is the Transpiration in mm. ET is the Evapotranspiration which is the total amount of water lost into the atmospheres through evaporation and transpiration in kg yield/m<sup>3</sup>, Potential yield is the yield of a crop cultivar grown in a water and nutrient non-limiting environment and free from all pests and diseases in other words the maximum yield a crop can attain. The actual yield is amount of crop that can be harvested per unit land area i.e. the green biomass yield while the Dry yield is the amount of dry crop (grains) harvested per unit land area both measured in tons per hectare.

Results from **Error! Not a valid bookmark self-reference.** show that there is no clear trend of either an increase or decrease in crop yields since 2003 and 2012. However the yields only increased or decreased depending on the amount of rainfall received during the particular season. It can be observed from the table that an increase in yields is influenced by a higher amount of rainfall received in the growing season. It's clear from the table that water productivity ET and Transpiration (Tr) only increased with an increase in seasonal rainfall too. However the reference evapotranspiration (ETo) and the potential biomass yield was almost the same for all the seasons since they're localized parameters which depends on the average weather conditions and soil characteristics. The Actual yield (Green Biomass yield) and the Dry yield which is the grain yield for each season varied due the fact that it is dependent on rainfall and other factors that influence production.

**Table 5.1** A decade Analysis of Rain-fed Agriculture for the growing season (March – June)

Year	Seasonal Rainfall (mm)	ETo (mm)	Tr (mm)	ET (kg yield/m <sup>3</sup> )	Potential Yield (ton/ha)	Actual Yield (ton/ha)	Dry Yield (ton/ha)
2003	795	537	339	1.42	13.67	13.3	6.808
2004	426	553	226	1.16	13.7	8.6	4.285
2005	608	539	309	1.38	13.8	12.2	5.986
2006	423	534	229	1.14	13.8	9.0	4.061

<b>2007</b>	510	546	287	1.56	13.9	11.7	6.321
<b>2008</b>	<b>409</b>	<b>528</b>	<b>176</b>	<b>1.01</b>	<b>13.9</b>	<b>7.1</b>	<b>3.389</b>
<b>2009</b>	<b>360</b>	<b>532</b>	<b>201</b>	<b>1.13</b>	<b>14.0</b>	<b>7.9</b>	<b>3.915</b>
<b>2010</b>	628	525	347	1.53	14.0	14.0	7.022
<b>2011</b>	<b>423</b>	<b>551</b>	<b>313</b>	<b>1.47</b>	<b>14.1</b>	<b>12.6</b>	<b>6.252</b>
<b>2012</b>	647	524	281	1.34	14.2	11.8	5.692

#### 5.8:2: Net irrigation water needs for Maize

Figure 5.7 represents the Net irrigation seasonal water needs for maize analyzed for ten years using the model. The upper line graph shows the Net seasonal Supplemental irrigation water needs to keep the soil moisture always at a fixed level which is between the threshold for leaf expansion and the threshold for stomata closure. The maximum values for net irrigation water needs are observed with years that have low amounts of rainfall during the growing seasons and these are mainly 2004, 2006, 2008 and 2009. The lower line graph represents the potential annual surface runoff that can be collected over a catchment area of only one hectare calculated using the model.

Aquacrop is used to calculate the total annual cumulative surface runoff that can be collected over a catchment of one hectare. In reality, a catchment area can be either bigger or smaller than one hectare depending on the slope which influences the gravitational flow of the runoff to the collection point. Aquacrop also calculates the net irrigation water needs using the threshold called the Allowable root zone depletion. This is expressed as a percentage of Readily Available Water (RAW). So Figure 5.7 tries to give a realistic picture about the needed amount of water for irrigation (demand) and the potentially available annual surface runoff that can be used as irrigation water (supply).

Readily Available Water (RAW) is the water which can be easily extracted from the soil by the growing crops. RAW is 0% at field capacity, 50 % at the first threshold of leaf expansion and growth and finally RAW becomes 100% at the threshold for stomata closure. There are different ways to calculate the net irrigation water requirements depending on the crop under cultivation, rainfall availability, variety of the crop, evapotranspiration and also the available soil moisture. In this study, the net irrigation water needs for maize are estimated by keeping the soil moisture

between the two thresholds, the threshold for leaf expansion and the threshold for stomata closure.

At this level, RAW is 75%, this means that the available water in the soil root zone is not in excess to initiate runoff and still the level of soil moisture is not very low to create a negative effect on the growth and production of the crops. When the soil moisture is kept at 50% RAW, most of the water is used for leaf expansion and canopy growth, meaning less water is left for grain formation. At the same time when the soil moisture is kept at 100% RAW, the available water in the soil root zone is not enough which triggers the closure of the leaf stomata hence reducing the crop water productivity.

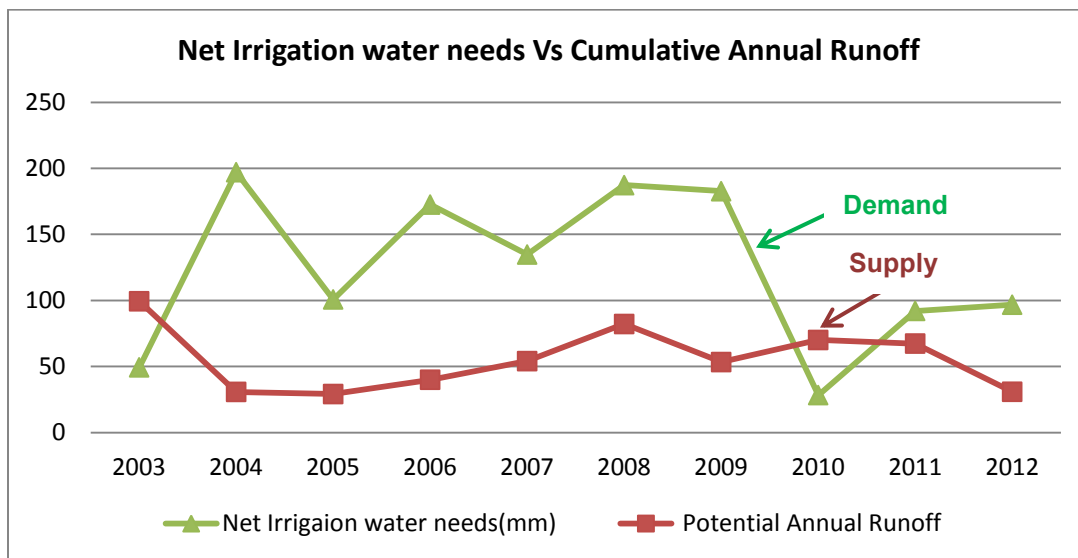

**Figure 5.7** Net Irrigation water needs and Potential Cumulative Annual runoff (Irrigation Demand Vs Supply)

### 5.8:3: Reducing the Maize water gap

Figure 5.8 compares the average seasonal maize water needs for the study area which is set at 580mm for each season while keeping other factors constant, the total seasonal rainfall received over the study area for a period of ten years and then a combination of total seasonal rainfall and Annual cumulative runoff supplied as supplemental irrigation. The later assumes a scenario where supplemental irrigation can be applied using surface runoff. These values per unit area are calculated using the model to give an insight about the existing irrigation water gap between the seasonal crop water needs and the seasonal cumulative rainfall. The growing season in the study area is from March to June. These results explains the significance of supplemental irrigation using runoff water as to reduce the water gap between what is needed and what is supplied.

Maize crops require an average seasonal water needs between 500 – 800mm depending on the cultivar of the crop, soil characteristics and climatic conditions of the area. The seasonal water

needs for maize in the study area is 550mm or more, that's why it is set to a constant value in all the growing seasons for the different years.

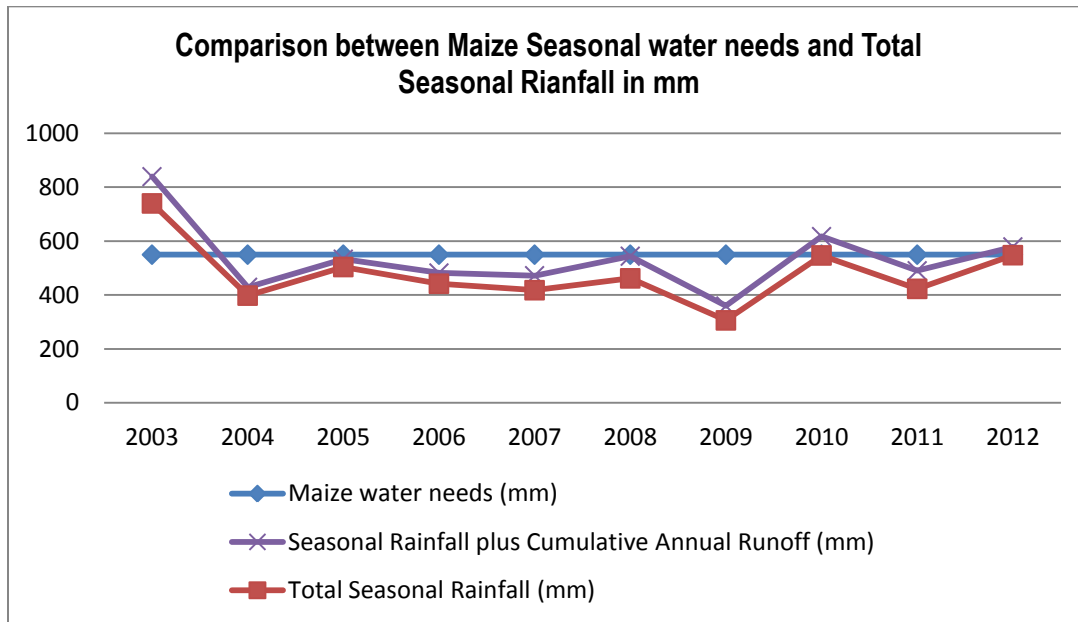
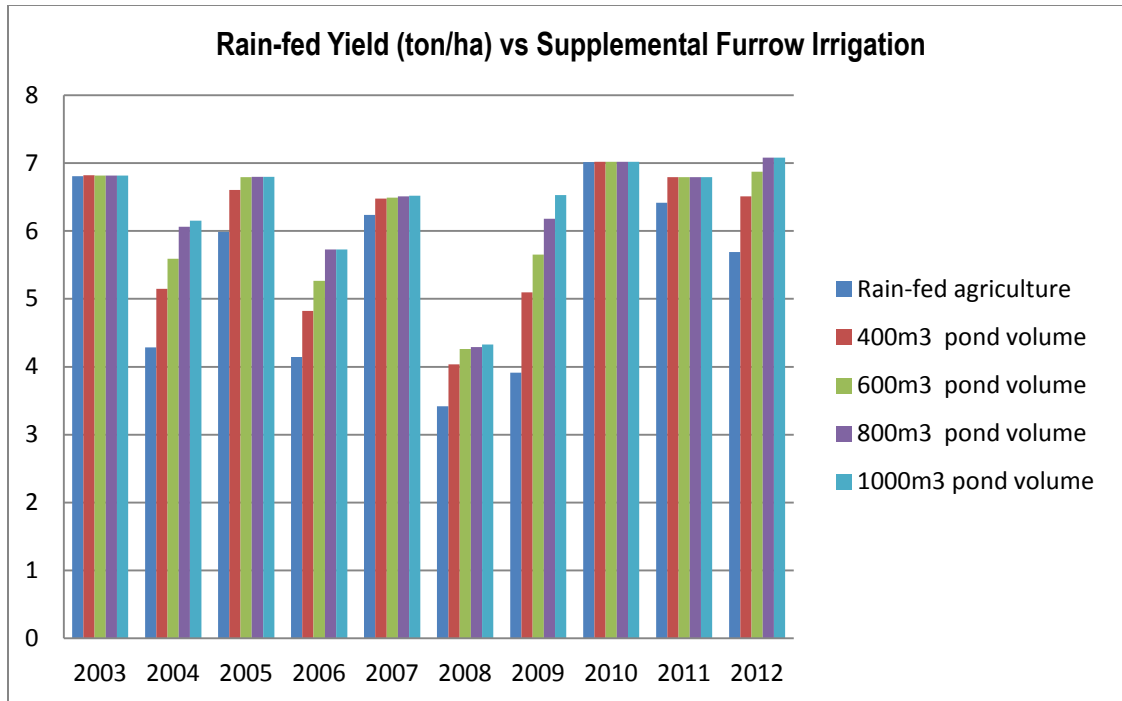

**Figure 5.8** Irrigation water gap

#### 5.8:4: Optimization of the pond size/volume

Different simulations and continuous runs are conducted in this study to find answers for the research questions that were stated in the first chapter. After estimating the cumulative total annual surface runoff by the model, the study found that the maximum amount of runoff that can be collected from a hectare catchment is 100mm and the minimum at about 30mm. With these values, different alternative pond volumes are proposed that can be used to collect the all year around runoff for supplemental irrigation of maize in the critical stages. The capacities that are examined in this study are 1000, 800, 600 and 400 m<sup>3</sup> pond volumes.

Figure 5.9 shows the total yields in ton/ha with Rain-fed Agriculture alone and Supplemental Furrow Irrigation using different pond volumes over the critical growth stages of maize crops under a one hectare land. The study found that that the optimal pond capacity is 800 cubic meter pond for surface runoff to supply irrigation water for an agricultural land area of one hectare. As elaborated earlier in Chapter 4, the study analyzes the four different pond capacities of 1000, 800, 600 and 400 cubic meter volumes to supplement rain-fed system. Of all the four volume alternatives, the 800 cubic meter pond is estimated to be the optimum pond volume and the most efficient pond capacity that gives the highest increase in yields in for a hectare of agricultural land.

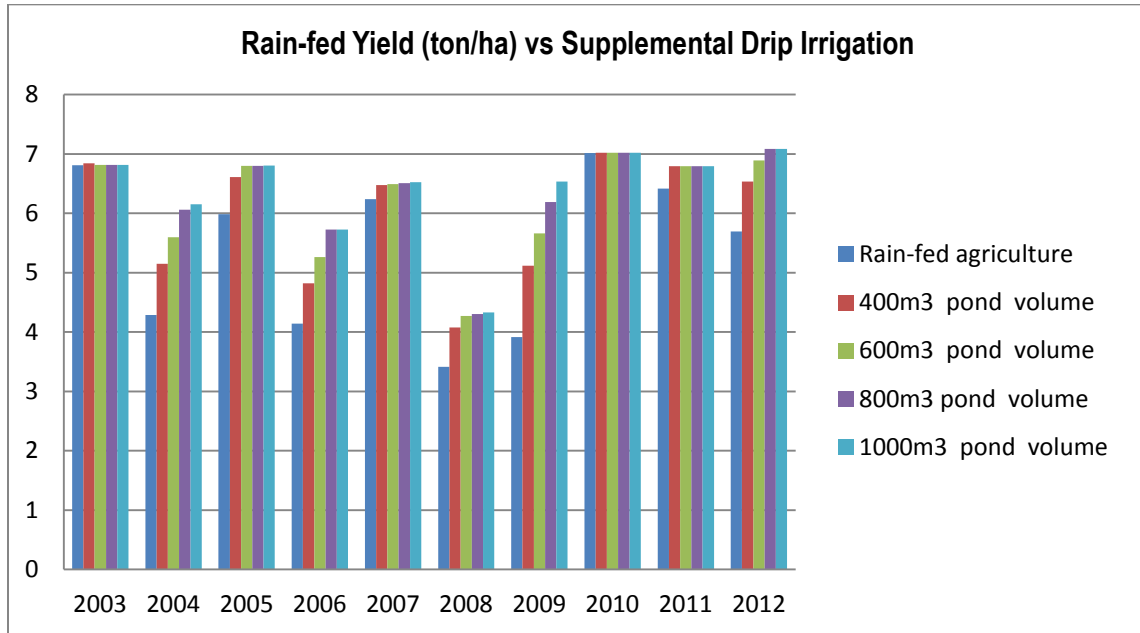

**Figure 5.9** Yield (ton/ha) for Supplemental Furrow Irrigation

In other results, Figure 5.10 shows rain-fed and supplemental Drip irrigation for maize. As an alternative form of irrigation, this study tested the possible yields by using drip irrigation in the model simulation. Drip irrigation and furrow irrigation are two quite different types of irrigations. They differ in all means such as the way irrigation water is applied to the crops, pressure and speed of application, flow rates, etc. The most common form of irrigation in cereal crops in particular maize is the furrow irrigation. Although it is a cheap method to use, it consumes a lot of irrigation water whereby more than 40 - 60% of the soil surface is covered. Water coverage is greater in closely spaced crops. However the drip irrigation system is more preferred for water efficiency since it only covers about 30% of the soil surface. The drip system specifically supplies water at the exact point of the crop stand. So both systems are tested in this study to see which is more productive. Figure 5.9 and Figure 5.10 illustrates furrow and drip irrigation respectively. This study found very miniature differences between the yields of the two systems. Nevertheless it's the drip irrigation that had higher values in yields than the furrow irrigation in some few seasons.

Figure 5.10 show the total yields in ton/ha with Rain-fed Agriculture alone and then Supplemental Drip Irrigation using different pond volumes over the critical growth stages of maize crops under a one hectare land. Although irrigation of the maize croplands in most parts of the globe is furrow irrigation, this study tried to test the maize yield with drip irrigation. The results presented in Figure 5.10 shows the maize crop yields using the drip system. Results are not that different from the results achieved with furrow irrigation except in a few seasons. Additionally the cost of drip

irrigation being higher than that of furrow irrigation, the later is normally preferred for maize crop irrigation.



**Figure 5.10** Yield (ton/ha) for Supplemental Drip Irrigation

The graph in **Figure 5.11** illustrates the yield relationship between furrow and drip irrigation using the 800 cubic meter pond to irrigate a hectare of maize cropland. This is intended to compare the maize yields that could be attained while using both of the irrigation systems. The yields turned out to be almost the same just with few differences in the case of drip irrigation. The main difference that is spotted in this comparison is the irrigation efficiency. Drip irrigation uses less water compared to the furrow system though with fewer differences in yields while applied on the same acreage of cropland.

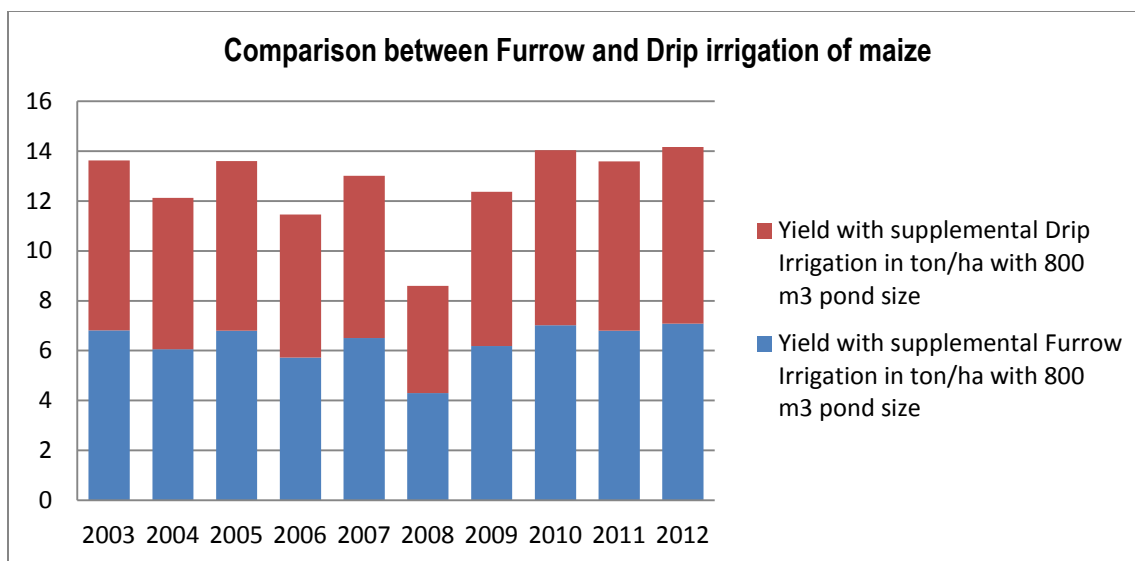

**Figure 5.11** Furrow and Drip irrigation

### 5.8:5: Temperature and Rainfall variability

The study also applied some statistical tools to find out the influence of temperature on rainfall. When the climatic data (daily rainfall and daily average temperature) was subjected to regression in SPSS statistical analysis, daily average temperature was analyzed as the independent variable while daily rainfall was the dependent variable. From Figure 5.12, R Square indicates that the independent variable (daily average temperature) explains a 2.4% in the change (variation) of the dependent variable (daily rainfall). The SPSS results indicate that the model is significant at a 95% confidence interval. The results also show that when the temperature increases by one unit (degree), the amount of rainfall decreases by 0.947 units (mm).

Model	R	R Square	Adjusted R Square	Std. Error of the Estimate
1	.156 <sup>a</sup>	.024	.024	8.78714

**Figure 5.12** Regression Analysis

## 5.9: Discussion of Model Results

### 5.9:1: 10 years Rain-fed analysis

Amongst the 10 analyzed growing for seasons rain-fed reductions, some of the seasons received more rainfall than the others and hence they experienced few or no dry spells during the season, these include 2003, 2005, 2007, 2010 and 2012. These years had a cumulative seasonal rainfall greater than 500 mm. whereas the other years (2004, 2006, 2009, and 2011) experienced

frequent dry spells and the cumulative amount of rainfall received during the growing season was low and below 500mm.

The results from the model show that crop failures can be caused by short term agricultural droughts which can occur for just few days and the yields can be greatly reduced. This is evidenced from the simulated results of the model more particularly with the water stressed seasons such as the 2004, 2006, 2008 and 2009 which had very low dry yields without supplemental irrigation. Some seasons however like 2003, 2005, 2007, and 2012 had no water stress during the growth seasons, they therefore had a low yield increment of a maximum of 11% with supplemental irrigation. Seasons of 2003 and 2010 had the lowest yields with supplemental irrigation due to the fact that they received abundant rains during the growing season.

#### 5.9:2: **Net Irrigation water needs**

In regards to the net irrigation water needs of maize, Figure 5.7 shows a comparison between what is needed and what can be potentially supplied. Setting the soil moisture level at 75% creates limited tension or stress to the crop whereby it directs most of its available water needs to grain formation. This moderate level of water stress in the soil root zone induces more grain formation in many cereal crops. Actually soil root zone moisture at 75%RAW is known to have a positive increment on the crop yields. A percentage increase in the value of RAW means a decrease in the amount of soil moisture in the root zone till it reaches 100% at the threshold for stomata closure.

The irrigation water needs corresponds to the area subjected to the amount of soil moisture in the soil root zone. If the Allowable root zone depletion reaches 75% RAW, irrigation is initiated and when the amount of soil moisture is greater or equal to 75%, irrigation is terminated. Figure 5.7 shows that the net irrigation water requirements is still high even when set at a considerable RAW value with minimal moisture stress to the crop. This amount of water needed to cope with the irrigation demand can be achieved maybe with a larger catchment area, additional underground water pumping or stream diversion.

Aquacrop also estimates the potential cumulative runoff that can be collected in a year from a catchment of one hectare. These values for each year are compared to the net irrigation water requirements in the growing seasons. The results show that there is a limited possible water supply for irrigation of the crops from one hectare catchment. So, unless the catchment area is bigger than one hectare, there is need for additional irrigation water supply. Actually the maximum cumulative runoff estimated by the model annually is about 100mm from a catchment area of one hectare. This water is not even half the irrigation water demands for a full irrigation schedule for maize crops. This is why this study proposed a supplemental irrigation system and more specifically to be applied in only the critical growth stages of maize.



### 5.9:3: Reducing the maize water gap

In a way to cope with the water shortage in rain-fed agriculture, Figure 5.8 presents a better solution of how the water gap in maize production can be reduced. Applying supplemental irrigation reduces the moisture water demands by more than 50%. For a better understanding of this illustration, the maize seasonal water needs in the study area is 550mm and so it is set constant for all the growing seasons. It can be seen that, applying supplemental irrigation actually provides close to the needed seasonal water needs required by the maize crop to flourish and produce good yields.

In case of supplemental irrigation, results in

Results from **Error! Not a valid bookmark self-reference.** show that there is no clear trend of either an increase or decrease in crop yields since 2003 and 2012. However the yields only increased or decreased depending on the amount of rainfall received during the particular season. It can be observed from the table that an increase in yields is influenced by a higher amount of rainfall received in the growing season. It's clear from the table that water productivity ET and Transpiration (Tr) only increased with an increase in seasonal rainfall too. However the reference evapotranspiration (ET<sub>o</sub>) and the potential biomass yield was almost the same for all the seasons since they're localized parameters which depends on the average weather conditions and soil characteristics. The Actual yield (Green Biomass yield) and the Dry yield which is the grain yield for each season varied due the fact that it is dependent on rainfall and other factors that influence production.

Table 5.1 shows a percentage increase of between 25 to 50% compared to rain-fed system alone. These four seasons were actually considered as dry years by the Ugandan government since they had frequent dry spells and droughts that lead to the failure of almost all the crops nationwide and also led to the death of animals since there was inadequate water to feed the livestock (GOU, 2007).

This study's findings conform to the studies conducted by Rockstrom & Barron (2007) who reported that their crop yields increased by over 60% compared to rain-fed system. Other researchers found relatively similar results with just in the increment in yields for example Pandey, et al. (2013) Reported that growth seasons which were supported with supplemental irrigation during the growth cycle of crops had a 74% increase for dry seasons or water stressed seasons compared to the rain-fed. They also reported a maximum of 14% yield increase for the case of wet years or seasons that didn't experience water stress.

### 5.9:4: Optimization of the pond size/volume

Optimization results from this study found that the 800 cubic meter pond is the optimum water storage pond for a one hectare crop land of maize. Results show that actually the larger 100

cubic meter pond was found to have relatively similar crop yields with supplemental irrigation. Similar findings have also been reported by a number of authors (Pandey, Panda, & Panigrahi, Sizing on-farm reservoirs for crop-fish integration in rainfed farming systems in Eastern India. , 2006) (Pandey, Soupir, Singh, Panda, & Pandey, 2011) (Panigrahi, Panda, & Mull, 2001) who suggested that small water reservoirs for water collection during heavy rainfall events can produce a significant increase in crop yields when the water is supplied to the crops during the periods of critical water needs.

Findings from different authors (Rockström & Barron, 2007) (Pandey, Zaag, & Soupir, 2013) who have done related studies concerning runoff harvesting for supplemental irrigation of different crops in different locations for example in Kenya (East Africa) and Burkina Faso (West Africa) have reported up-to 38% increase in crop yields with smaller pond capacities.

Furthermore (Pandey, Panda, & Panigrahi, 2006) emphasized the use of smaller water ponds and in their study, they reported a higher increment in crop yields by developing smaller sized ponds for dry spell mitigation. Despite the many conducted studies on runoff harvesting, there seems to be few published data specifically for supplemental irrigation of maize crops which happens to be the staple food for most of the sub-Saharan African countries (Pandey, Zaag, & Soupir, 2013). Additionally (Rockström, Barron, & Fox, Water productivity in rain-fed agriculture: Challenges and opportunities for smallholder farmers in drought-prone tropical agro- ecosystems in Water Productivity in Agriculture: Limits and Opportunities for Improvements, 2003) estimated a pond size of 600 -900 cubic meters of water for supplemental irrigation in the case of sorghum. These authors went further to test the significance of their results (increment in crop yields) and they found out that they were significant.

There have been fewer research studies that were conducted in line to the economic feasibility of rainwater harvesting using excavated ponds as storage facilities to supplement rain-fed agricultural system. As the different pond capacities were thoroughly analyzed in this study, results showed that using a 1000 cubic meter pond volume for supplemental irrigation of maize crops could rather just reduce the benefits from production. Meaning large reservoirs do not necessarily increase per capita income from maize production in particular. This contradicts with a study that was conducted by Hanjra, et al. (2009), they proposed that increasing the size of the water reservoir would increase the yield of the crops and hence the profits from production.

Also a study by (Rockström, Barron, & Fox, Water productivity in rain-fed agriculture: Challenges and opportunities for smallholder farmers in drought-prone tropical agro- ecosystems in Water Productivity in Agriculture: Limits and Opportunities for Improvements, 2003) found that for a water pond of 2000 cubic meters of irrigation water was sufficient to increase annual crop production in rain-fed agricultural zones. In 2008, another study was conducted by (van der Zaag & Gupta, 2008), these two authors had different findings too. They reported that 1000 cubic meter

pond of water storage from rainwater harvesting would produce the highest yields from agricultural production under a one hectare crop land. However, all the above findings were conducted on a variety of different crops, this study focuses on maize production and the supplemental irrigation is only supplied during the critical growth stages and hence triggered by the shortage in soil moisture.

Large water facilities or dams do not only reduce benefits from production but also have negative environmental impacts. These findings were also presented by (McCartney & Smakhtin, 2010) who emphasized the fact that large water reservoirs have negative consequences to the community where they are established. First of all, large water reservoirs or dams occupy a very large surface area which reduces the area under crop production. Additionally some few studies have also presented similar findings that large water reservoirs/dams/ponds have negative social – environmental and economic impacts (FAO/IIASA, 2000). FAO reported that these big water facilities are very paramount in environmental degradation, distortion of the soil structure and underground water movement hence leading to disastrous natural disasters like floods, earthquakes and drought.

#### 5.9:5: **Temperature and Rainfall variability**

Regression analysis is conducted to find out whether temperature has an effect on rainfall. The results presented in Figure 5.12 technically means that if there is an increase in daily temperature by one degree centigrade, rainfall will decrease by 0.947mm. However it should be noted that there are various factors that affect or influence rainfall occurrence. As stated in the previous paragraph, temperature only contributes 2.4% of rainfall occurrence; the other 97.6% is influenced by other different factors like topography, green cover, wind etc.

### 5.10: **Cost Benefit Analysis results and Discussion**

To develop the Cost Benefit Analysis, the yield benefits or yield values from the simulated historical data running from 2003 to 2012, they are converted into monetary form (money) by multiplying the yield in tons for each season basing on the current price of 1,200,000 UGX per ton as of the price of maize grain for 2017 (TradingEconomics, 2017). By this way the yield for the entire four pond capacities are monetized in addition to the rain-fed yield without irrigation. The irrigation method used to simulate these results was supplemental furrowing irrigation only.

#### 5.10:1: **Monetary Yields for Different pond volumes for 10 years in UGX (Historical)**

**Table 5.2 summarizes the results of simulating the use of different pond sizes ranging from 400 – 1000 cubic meters water volumes. It shows how these pond sizes will affect the production for the years from 2003 – 20012 with the exact rainfall patterns in these years. The study used the ten years because it was assumed that these ten years are typical ten years not too wet and not too dry. So the assumption is that these ten years are typical years and can be repetitive, having twenty years study would mean that it's another cycle for these same ten years. It can observed from the results in**

Table 5.2 that the system without irrigation has the least cumulative value from the yields and followed by the supplemental irrigation system with the smallest volume of irrigation water i.e. 400 cubic meter pond, then the 600, 800 and then the system with the highest amount of irrigation water in this case the 1000 cubic meter pond had the highest monetary value since it also has the highest grain yields. This is the historical benefit analysis for the systems and only based on the grain yield in accordance to the amount of water irrigated during the critical stages of the growth cycle. These results are used to calculate the Average Annual Growth. UGX is the Ugandan currency and **\$1 US is equivalent to 3550 UGX.**

**Table 5.2** Historical Seasonal Monetary yields

Season	Different Pond capacities				
	1000 m3	800 m3	600 m3	400 m3	No Irrigation
<b>2003</b>	8,179,200	8,180,400	8,181,600	8,188,800	8,169,600
<b>2004</b>	7,382,400	7,273,200	6,711,600	6,176,400	5,142,000
<b>2005</b>	8,161,200	8,158,800	8,155,200	7,924,800	7,183,200
<b>2006</b>	6,874,800	6,872,400	6,316,800	5,786,400	4,972,800
<b>2007</b>	7,826,400	7,810,800	7,790,400	7,771,200	7,485,600
<b>2008</b>	5,192,400	5,150,400	5,115,600	4,840,800	4,099,200
<b>2009</b>	7,833,600	7,419,600	6,783,600	6,114,000	4,698,000
<b>2010</b>	8,426,400	8,426,400	8,426,400	8,426,400	8,419,200

<b>2011</b>	8,154,000	8,154,000	8,154,000	8,154,000	7,702,800
<b>2012</b>	8,500,800	8,498,400	8,250,000	7,814,400	6,830,400
<b>Total (UGX)</b>	76,531,200	75,944,400	73,885,200	71,197,200	64,702,800
<b>Total (US \$)</b>	21,558	21,392	20,812	20,055	18,226

### Average Annual growth

Basing on the monetary values for each season of the historical data, the Average Growth- Year over Year (YOY) is also calculated. The Annual yield is calculated with the following equation:

$$\text{Annual Yield Growth} = \frac{\text{Yield in Present year} - \text{Yield in Previous year}}{\text{Yield in Previous Year}} \times 100 \quad (9)$$

From equation **Annual Yield Growth** =  $\frac{\text{Yield in Present year} - \text{Yield in Previous year}}{\text{Yield in Previous year}} \times 100$  (9) (SIBs, 2017), the study calculates the Annual Average growth for Irrigated agriculture which is found to be **2.86%**, however this rate doesn't take into consideration the rain-fed system alone (without irrigation) since it's not part of the irrigation strategies. The calculated annual average growth rate is then used to forecast the future yield values for a period of 17 years.

The period of forecast is selected to be 17 years to fit the life span of all the water lifting alternatives in this study, for instance, the rope and bucket has to be replaced every year, the treadle pump has be replaced every after 6 years, the solar pump has to be replaced every 10 years and the diesel pump life span is estimated to be 20 years. In this case, setting a forecast of 17 years meant to avoid any costs for any of the lifting techniques without considering the respective benefits. For example the costs and benefits of the treadle pump are only considered for only two replacements since its life span is 6 years.

This still explains that the cost benefit analysis (CBA) does not include the costs for the third replacement nor its benefits. So, the would be third replacement for a treadle pump at 18 years' time is avoided by limiting the CBA to only 17 years. The same scenario applies to the solar pump which has to be replaced only once, so the benefits and costs are only estimated before the second replacement. It's obvious for the diesel pump because it does not need to be replaced for the period of 17 years yet the rope and bucket is replaced every year.

The considered starting year for the forecast is the present year 2017 till 2034; however the presented table for average growth starts from 2012 simply because the historical data that was collected for this study is from 2003 to 2012. Since there were no records from 2012 till 2017, and

2017 is the baseline year for the future predictions, this study makes predictions for the missing years till 2017 so as to have a baseline from the current year (2017). The values are also presented in Ugandan currency.

#### 5.10:2: Average Growth YOY (Forecast)

**Table 5.3** Monetary Yield Value (Forecast)

Season	Pond capacities				
	1000 m3	800 m3	600 m3	400 m3	No Irrigation
2012	8,500,800	8,498,400	8,250,000	7,814,400	6,830,400
2013	8,743,923	8,741,454	8,485,950	8,037,892	7,025,749
2014	8,993,999	8,991,460	8,728,648	8,267,776	7,226,686
2015	9,251,227	9,248,616	8,978,288	8,504,234	7,433,369
2016	9,515,813	9,513,126	9,235,067	8,747,455	7,645,963
<b>2017</b>	9,787,965	9,785,201	9,499,189	8,997,632	7,864,638
<b>2018</b>	10,621,635	10,618,636	10,308,264	9,763,988	8,534,493
<b>2019</b>	11,526,312	11,523,057	11,186,250	10,595,616	9,261,401
<b>2020</b>	12,508,042	12,504,511	12,139,016	11,498,076	10,050,222
<b>2021</b>	13,573,390	13,569,558	13,172,933	12,477,402	10,906,230

<b>2022</b>	14,729,476	14,725,317	14,294,911	13,540,139	11,835,146
<b>2023</b>	15,984,030	15,979,517	15,512,451	14,693,394	12,843,181
<b>2024</b>	17,345,437	17,340,540	16,833,693	15,944,874	13,937,074
<b>2025</b>	18,822,800	18,817,486	18,267,469	17,302,947	15,124,136
<b>2026</b>	20,425,995	20,420,228	19,823,364	18,776,691	16,412,304
<b>2027</b>	22,165,738	22,159,480	21,511,780	20,375,958	17,810,189
<b>2028</b>	24,053,660	24,046,869	23,344,003	22,111,439	19,327,136
<b>2029</b>	26,102,383	26,095,013	25,332,281	23,994,737	20,973,287
<b>2030</b>	28,325,601	28,317,604	27,489,908	26,038,441	22,759,644
<b>2031</b>	30,738,177	30,729,499	29,831,306	28,256,213	24,698,152
<b>2032</b>	33,356,240	33,346,823	32,372,128	30,662,879	26,801,767
<b>2033</b>	36,197,291	36,187,072	35,129,359	33,274,529	29,084,554
<b>2034</b>	39,280,323	39,269,233	38,121,432	36,108,620	31,561,773

### 5.10:3: **Net present Value (NPV)**

After the calculation of the yield forecast, the study goes further to calculate the discounted cash flow (DFC), by this kind of analysis, future cash flow from the forecasted yields is discounted to arrive to a present value for better comparison of the financial feasibility of the project under study. The equation for the present value is used to estimate the DFC from the present year 2017 till 2034 (SIBs, 2017) i.e.

$$PV = (1 + i)^{-n} \quad (10)$$

Where PV means the Present Value, i refer to the interest rate and n is the number of years. The interest rate that is used in this study is for the current year 2017 for the Ugandan economy which is 10% (TradingEconomics, 2017). All the values are presented in the Ugandan Currency UGX. The Net Present Values (NPV) is needed to better estimate the profitability of the project if farmers adopt and willingly invest their money in such a project of supplemental irrigation. Due to the fact that farmers only have one focal point in their farming system which is an increase yields hence an increment in income, the study calculates the NPV to measure the profitability of the investment. In the appendix, Table 0.1 in the appendix presents the cumulative DCF to reach a total NPV of the establishment of the different pond sizes that are proposed in this study.

A similar concept of Net Present Value (NPV) for the water lifting techniques is also applied with all the different alternatives of lifting water from the storage pond to be delivered to the crops. This is also forecasted for 17 years from the present year 2017. Since the forecast is set at 17 years, this period is longer compared to the life span of some of the lifting water techniques. This means that some of them will have to be replaced twice or more. Most probably all these future costs will have a different pricing different from the current prices, so they are subjected to an inflation rate. The inflation rate that is used in this study stands at 5.50% as of the trading economics of the Ugandan government (TradingEconomics, 2017). As described earlier in Chapter 4, the study tries to analyze the capital costs, operation and maintenance costs for all the alternative techniques which are: the rope and bucket, treadle pump, solar pump and diesel pump. The unit annual costs are presented at the end of Chapter 4.



#### 5.10:4: Optimization of Supplemental Irrigation

After the calculation of both the Net Present Values for the pond storage system and the water lifting techniques, in addition to the benefits from the supplemental irrigation scheme period, the most profitable duo system i.e. (the optimum pond volume and the most profitable lifting technique) in terms of money value is estimated. Figure 5.13 presents the most profitable supplemental irrigation for maize production in rain-fed systems. The presented values in the table are the profits for 17 years of applying the systems in Ugandan currency UGX.

From the model results, the 800 m<sup>3</sup> pond is proved to be the most optimum pond compared to all the rest of the proposed volume alternatives. With the complete analysis of the cost-benefit, the study finds that the most profitable system is the 800 cubic meter pond along with the diesel pumping technique using furrow irrigation. Due to the high number of workers required for the rope and bucket system to carry out the manual irrigation activities, it makes the system unfeasible to implement on such a large scale of a hectare piece of land. All the values are in negatives, meaning no profits can be attained using such a method on a large scale.

The rope and bucket system is a traditional method which has been used for decades. It was an option before the spread of other new techniques like the water pumps. Since the spread of the improved and more efficient techniques of water lifting, this system started fading and its use is only limited in the most rural and poor communities. Though still some few people think of it as an option for irrigating horticultural crops and vegetables. Most of these crops have a short growth period of less than 2 months and are grown on a very small piece of land of less than an acre such as home gardens, backyards etc.

Regarding the treadle pump, actually it gives very good profits even more than the solar pump though still low compared to the diesel pump. The treadle pump is a new technique that has just been introduced in the country originally from South Asian countries. It requires only two persons to conduct the irrigation and it not that expensive to purchase. This means its operation costs and maintenance costs are lower. Concerning the solar pump, its profitability is lower compared to the treadle and the diesel pump. This might be because of its high purchasing costs since it is still a new technology in the area though it has very important significance of being environmentally friendly.

The diesel pump presents the highest profits amongst others maybe because of its durability (very long life span if maintained well). However it poses a great challenge to the environment since the system uses fossil fuels to operate by burning fuel.

Furthermore the study calculated the payback period or the break even period for the selected system (800m<sup>3</sup> /diesel pump) to be 6.02 years. This means that after the 6 years, the farmer can have his/her total costs equal to the total revenue.

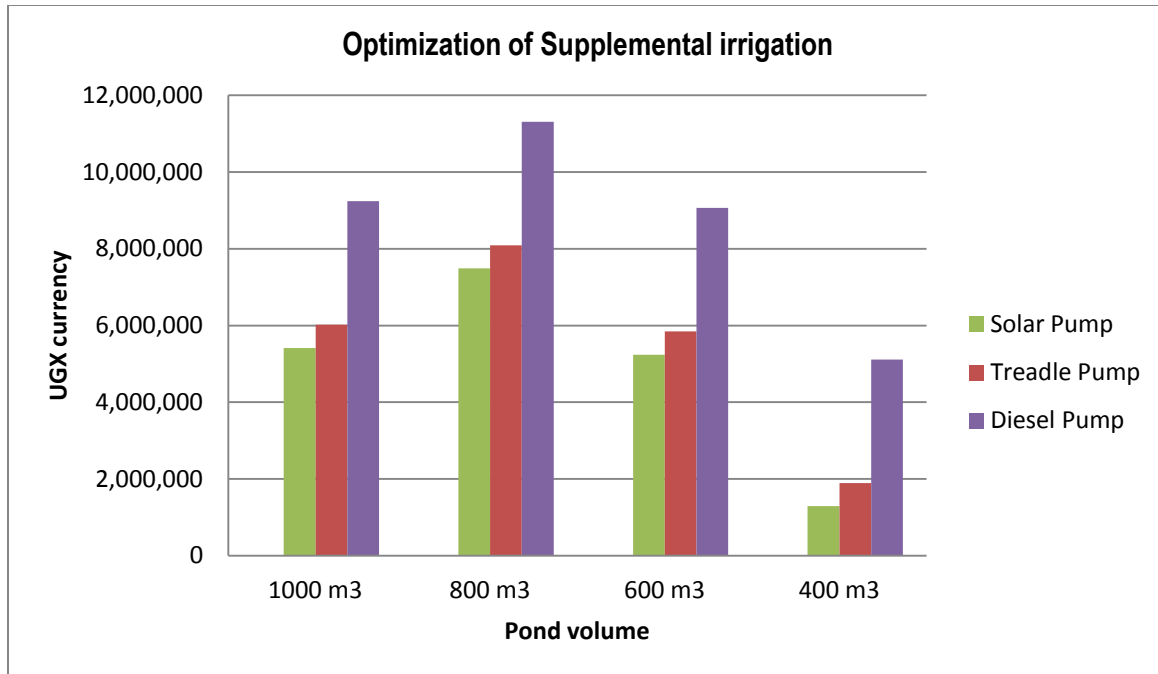

**Figure 5.13** Profitability of different pond sizes with different lifting techniques

## Chapter 6. **Conclusions and Recommendations**

### **General Conclusions**

In efforts to handle the growing food demands, there is need to change the mindset of the poor illiterate famers in Africa. However much the governments try to invest in more of the same, it is unlikely to produce better results. Weather patterns are changing drastically and rainfall is becoming more erratic with non-uniform distribution. Farmers need to embrace the fact that rainfall is not anymore sufficient for their crops. In many of the rain-fed agricultural zones, low crop yields are attributed due to low soil moisture, inappropriate management of soil and other field practices. Shortage of soil moisture due to short droughts and dry spells especially during the critical crop growth stages (flowering and grain filling or formation) can lead to severe losses of crop harvests. Such challenges can be mitigated through the application of supplemental Irrigation as a strategy to minimize or reduce crop failures.

This study presents a simple sustainable economic solution for the problem of crop reductions due to short droughts and dry spells during the rainy seasons. Maize being one of the most important staple foods in almost all regions of Sub-Saharan Africa, its production has greatly decreased because of water shortages during the growing period. So this study proposes that if a farmer can sacrifice 5% of his cropland to construct a micro storage system that can collect surface runoff and use it primarily during the crop critical growth period of 2 weeks for a maize crop, it can greatly reduce the crop failures to a larger extent. Such a system of a low finance can maintain higher crop production of any crop even when the area is subjected to intermittent droughts during the rainy seasons. The study suggests a small sized pond because large storage systems have a higher financial investment that may not be afforded by a small scale farmer unless there is an intervention by the government to fund such a project.

The findings of the study further suggests an optimum sized pond of 800 cubic meters by volume to protect a one hectare piece of cropland from being severely affected by short droughts during the critical growth stages. This system proves to be more profitable with such a pond size but it if the farmer has a small piece of land less than one hectare, it is important and economical to use a small pond size. For instance, if the farmer practices all his/her agricultural activities on half a hectare of cropland, then it is better to have a 400 cubic meter sized pond.

### **Conclusion related to the cost benefit analysis**

Furthermore the proposed scheme in this study is financially viable and economical. A cost benefit analysis is developed and the results shows that with such a low investment, there is a considerable increase in yields and the benefits can exceed the total costs in a few years. The calculated payback

period from the simulation model is 6 years which is quite a short time in the agricultural industry. This is achieved by employing a simple excavated open water pond lined with plastic polyethylene sheets for runoff storage and covered with Azolla for control of mosquito breeding. Since almost all agro ecological zones in Uganda receive at least a single relatively heavy rainfall season annually, regardless of onset and distribution of rains, surface runoff harvesting during the wet seasons provides a tremendous opportunity for collecting and storing water. The stored water can sustain crop production when used for supplemental irrigation during periods of drought or intermittent rains. Such a relatively cheap technology could greatly facilitate the up scaling of rainwater harvesting for small scale irrigation; this would in turn facilitate continuous crop production during the growth seasons and reduce crop failures in times of drought. This would thus boost farmers' yields and prevent crop loss due to insufficient or unevenly distributed rainfall.

### **Conclusion related to the model**

The study makes use of the crop water productivity model (Aquacrop) to estimate and predict the yield of supplemental irrigation using data from the study area in Eastern Uganda. The model is found very useful in relating climatic data more particularly rainfall patterns to crop yields. Model simulations and runs show that years that had higher amounts of rainfall during the growing seasons exhibited higher crop yields compared to the seasons with low rainfall amounts. Such a model can be utilized for other locations anywhere in the world to estimate crop yields in relation to rainfall patterns for that specific location. It is observed from the model that benefits from supplemental irrigation can vary between growth seasons depending on the rainfall patterns and distribution, type and cultivar of the crop, time of water application, cultural practices like mulching, fertilizer applications and other so many other factors which contribute to the final yield of the crops.

The setbacks for adopting such a system may range from, illiteracy, low economic power and lack of skilled extension workers to teach and spread the awareness amongst the local farmers of such practices to mitigate drought. To facilitate adoption by small holder farmers will necessitate the organizations spearheading the promotion of rainwater harvesting for supplemental irrigation to focus on cheap and locally available technologies. One such technology which is the focus of this research is having an open excavated plastic lined pond; cultivated with an aquatic plant (azolla) and an irrigation water lifting system that best suits the farmer depending on his/her financial ability.

### **Recommendations for the farmer**

The study findings proved that for supplemental irrigation of maize, a pond capacity of 800 cubic meters with a diesel pump can produce the highest yields per unit area. This system proves to be more profitable but it may have limitations due to the high initial investment. So for a small scale farming business, it can only be implemented by some few farmers but not all of them due to financial constraints. Meaning that with whatever pond size that may be established, the diesel and solar pumps leave the farmer with

fewer choices to be applied because of their high initial costs except with some financial support from the government or Non-Governmental Organizations (NGO's).

However, considering the farmers' context in the region and the study area in particular, their financial capability is low since they mostly practice subsistence farming. This means that they grow most of their food for home consumption while a surplus is for trade, this practice can be sustainable though it keeps the farmers' economic power always low. So a better recommendation would be having the optimum 800 cubic meter pond for a one hectare piece of land with a treadle pump because it is cheaper to purchase and maintain compared to the solar or diesel pump and it can also be operated by the family labor without employing external labor.

This system (800m<sup>3</sup>/treadle pump) is also a profitable venture that has a shorter payback period and at the same time it can help sustain production while reducing crop failures and it requires lesser capital that can be afforded by the local farmer. Due to the lower capital investment and the use of the family labor (two operators), the farmer can easily secure a small loan that can be easily paid back from the farmers groups or from a banking institution. Fencing around the pond is also recommended for safety reasons.

In case of a smaller cropped area that is less than a hectare of land (approx 3 acres), then a smaller capacity pond of about 300 - 400 cubic meters would be recommended but still with a treadle pump. The rope and bucket technique can be best while cultivating vegetable crops which are characterized with a smaller cropping area of less than an acre of land. The farmer in this case can easily lift water in a bucket and with the guidance of the gullies or furrows; water can be delivered to the different parts of the gardens.

### **Recommendations for further research**

First and foremost additional research in the area of supplemental irrigation is very vital due to the fact that there is only few published data in such a broad and important area of research. In this study, we considered a number of assumptions to generate the study's results. These results are based on the data from the study area, so the results are area specific. This means that if the model is applied to other areas with different climatic and soil data, the results may be different. The crop under investigation in the study is a maize crop which still has different moisture critical stages, different water needs and as well different growth patterns compared to other crops. So all these differences are possible areas of research which needs to be covered.

The study did not give an account or details of the pond balancing for the whole year, it only focused on the two weeks critical period of supplemental irrigation during the growing season of the maize crop. Further research could be of greater significance with more realistic results if the full year pond balancing is put under consideration. The study proposes growing azolla on the pond during the whole year when the pond is not under its primary use. However the economic benefits of this plant are not analyzed nor

the value of the 5% sacrificed piece of land that is used for the establishment of the storage pond. These are all potential areas of future research.

The study further generates some important research questions that may be used in my future further studies or used by other researchers who have interest in this area of concern. Among the research questions are:

What if the calculated cost of the pond can be done in a more realistic way that could give a slightly different pond size?

What if the calculated size of the pond can be done using a longer rainfall records of more than 10 years, would climate change have a serious effect on the length of the drought period and if so, by how many additional days?

What if the supplemental irrigation is set to be applied also during other growth stages in case of occurrence of a short drought or dry spell?

So if all these assumptions can be revisited and modified, maybe the results can be also improved.

Yield improvement in crop production is not only attributed by the soil moisture content, it's a combination of so many other factors which include field practices like mulching, fertilizer application, deep plough, weeding, crop-rotation and so many other practices. These in combination with supplemental irrigation can give tremendous yield results at the end of the growing season. More research with such settings of combining supplemental irrigation with such practices is still lacking.

Lastly there is great need of conducting participatory research with full inclusion of women in all agricultural community research projects because women play a central role in food production among the developing countries. More research should also be done in areas of macro water harvesting systems since the production with small micro or in-situ harvesting strategies is gradually deteriorating. Such systems were significant with reliable rainfall and at the times of occasional infrequent drought.

## Works Cited

- Baguma, D., & Loiskandl, W. (2010). Rainwater harvesting technologies and practises in rural Uganda: A case study. *Mitig Adapt Strateg Glob Change*, 355–369.
- AbdelKhaleq, R. A., & Ahmed, I. A. (2007). Rainwater harvesting in ancient civilization in Jordan. *Water Science Technology*, 85–93.
- Abdulkadir, A., & Schultz, R. C. (2005). 2005. Water harvesting in a runoff-catchment agroforestry system in the drylands of Ethiopia. *Agrofor. Syst.*63, 291–298.
- Allen, R. G., Pereira, L. S., Raes, D., & Smith, M. (1998). *Crop evapotranspiration - Guidelines for computing crop water requirements - FAO Irrigation and drainage paper 56*. Rome: FAO - Food and Agriculture Organization of the United Nations.
- Ashraf, H., Matto, F., Ganai, A., Reshi, I., & Sheikh, F. (2015). Effect of replacement of mustard oil cake with Azolla (*Azolla pinnata*) meal on growth performance of broilers and economics of feeding under temperate conditions. *Indian J Anim Nutr* , 32:325–328.
- Awodun, M. (2008). Effect of Azolla (*Azolla* species) on physiochemical properties of the soil. *World J Agric Sci* , 4:157–160.
- Basalirwa, C. (1995). C. P. K. Basalirwa (1995) *Delineation of Uganda into climatological rainfall zones using the method of principal component analysis*.
- Bekele, T., Kebede, H., Taddese, G., & Peden, D. (2006). *Small-scale irrigation practices and crop & livestock water requirements for better production by smallholder farmers: a cursory study on SG-2000 water harvesting and utilisation pilot project*. Addis Ababa, Ethiopia.
- Benicke, C. (2001, January). Costs and Benefits of Adopting Runoff Irrigation Systems . Kakuma, Northern Kenya , Kenya.
- Biazin , B., Sterk, G., & Temes, M. (2012). Rainwater harvesting and management in rainfed agricultural systems in Sub-Saharan Africa : A review. *Physics and Chemistry of the Earth*, 139-151.
- Boers , M. T., & Asher, B. J. (1982). A REVIEW OF RAINWATER HARVESTING. *Agricultural Water Management*,, 145-158.
- Boers, T. M., & Ben-Asher, J. (1982). A review of rainwater harvesting. *Agric. Water Manage*, 145–158.
- Brouwer , P., Van der Werf , A., H, S., Nierop , K. G., & Reichart, G. J. (2015). Lipid yield and composition of *Azolla filiculoides* and the implications for biodiesel production. . *Bioenergy Res*, 1-9.
- Brouwer, C., & Heibloem, M. (1986). *Irrigation Water Management: Irrigation Water Needs*. Rome: FAO, Food and Agriculture Organization of the United Nations.
- Carter, D. C., & Miller, S. (1991). Three years experience with an on-farm macro-catchment catchment water harvesting system in Botswana. . *Agric. Water Manage*. , 19, 191–203.

- Casenave, A., & Valentin, C. (1992). Arunoff classification system based on surface features criteria in semi-arid areas of West Africa. *Journal of Hydrology*, 231-249.
- Chartres, C. (2009). *Funding the Blue Revolution*. Retrieved from International Water Management Institute. IWMI: <<http://www.iwmi.org>>
- Chenery. (1960). *Introduction to the soils of the Uganda Protectorate, Memoirs of the Research Division, Series 1- Soils, Number 1*. Kampala: Department of Agriculture, Kawanda Research Station, Uganda.
- Critchley, W., & Siegert, K. (1991). *A Manual for the Design and Construction of Water Harvesting Schemes for Plant Production*. Rome: FAO.
- Driessen, P., & Deckers, J. (2001). *LECTURE NOTES ON THE MAJOR SOILS OF THE WORLD*. Rome: FAO.
- Dusabimana, T. (2012). Irrigation practices and water management in Rugeramigozi Marshland - A case study of surface irrigation in Rugeramigozi Marshland, Rwanda.
- Falkenmark, M., & Rockström, J. (2006). The new blue and green water paradigm: Breaking new ground for water resources planning and management. *J Water Res*, 132(3) 129 - 132.
- Falkenmark, M., Fox, P., Persson, G., & Rockstrom, J. (2001). *Water harvesting for Upgrading of Rainfed Agriculture*. Stockholm: Stockholm International Water Institute.
- FAO. (1991). *A Manual for the Design and Construction of Water Harvesting Schemes for Plant Production*. Rome.: FAO.
- FAO. (1995). *Irrigation in Africa in Figures*. Rome: FAO.
- FAO. (2013). *Global Yield Gap Atlas*. Retrieved from FAO Crop Calendars for Maize, Sorghum, Millet, Rice and Barley:  
<http://www.yieldgap.org/gygamaps/pdf/Details%20on%20crop%20information%20to%20calibrate%20crop%20models%20for%20Uganda.pdf>
- FAO. (2016, April). *Aquacrop*. Retrieved from Food and Agriculture Organization of the United Nations: [www.fao.org/aquacrop/en/](http://www.fao.org/aquacrop/en/)
- FAO, T. (2012). *Food and Agriculture Organization of the United Nations. Project Document: Global Climate Change Alliance (GCCA) – Uganda: Agriculture Adaptation to Climate Change. Republic of Uganda*. . Rome: Food and Agriculture Organization of the United Nations.
- FAO/IIASA. (2000). *Global agro-ecological zones*. Rome, Italy: FAO; Laxenburg, Austria: IIASA. : FAO/IIASA (Food and Agriculture Organization and International Institute for Applied Systems Analysis) .
- Flintan, F. (2011). *CHANGING NATURE OF GENDER ROLES IN THE DRYLANDS OF THE HORN and EAST AFRICA: IMPLICATIONS FOR DRR PROGRAMMING*. REGLAP.
- Fox, P. (2001). *Supplemental irrigation and soil fertility management for yield gap reduction: On-farm experimentation in semi-arid Burkina Faso*. Stockholm University, Sweden: Natural Resources Management. Department of Systems Ecology.



- Fox, P., & Rockstrom, J. (2003). Supplemental irrigation for dry-spell mitigation of rainfed agriculture in the Sahel. *Agric. Water Manage.*, 29-50.
- Freitas, A. (2013). *Water as a stress factor in sub-Saharan Africa*. European Union Institute for Security Studies.
- Gaind, S., & Singh, V. Y. (2015). Soil organic phosphorus fractions in response to long-term fertilization with composted manures under rice wheat cropping system. *cropping system. J Plant Nutr.*
- GOU. (2007). *Climate change: Uganda National Adaptation Programmes of Action*. . Kampala: Environmental Alert, GEF, UNEP.
- Griffin, R. C. (1998). The fundamental principles of cost-benefit analysis. *Water Resources Research* , 34, 2063-2071. .
- Hamdi , Y. (1982). *Application of nitrogen-fixing systems in soil improvement improvement*. FAO.
- Hanjra, MA, Ferede, & Gutta, D. (2009). Pathways to breaking the poverty trap in Ethiopia: Investments in agricultural water, education and markets. *. Agr Water Manage* , 96(11):1596-1604.
- Helmreich, B., & Horn, H. (2009). Opportunities in rainwater harvesting. *Desalination*, 118-124.
- Humphreys, E., & Bayot, R. S. (2009). Increasing the productivity and sustainability of of rainfed cropping systems of poor smallholder farmers. In: Proceedings of the CGIAR Challenge Proram on Water and Food International Workshop on Rainfed Cropping Systems, Tamale, Ghana, 22–25 September . *The CGIAR Challenge Program on Water and Food*,, (p. 311 ). Colombo, Sri Lanka, .
- Imbahale, S. S., Mweresa, C. K., Takken, W., & Mukabana, W. R. (2011). Development of environmental tools for anopheline larval control. *Parasites & Vectors*2011,4:130, 4, 130.
- Kaaya, A. K., Balthazar, M. M., & Mrhvia, J. P. (1994). Soils and land evaluation of part of the sokoine University of agriculture farm (Tanzania) for Some crops under rainfed conditions.
- Kaboré, P. D., & Reij, C. (2004). *The emergence and spreading of an improved traditional soil and water conservation practice in Burkina Faso*. *Environment and Production Technology Division Discussion Paper 114*. Washington, DC: IFPRI.
- Kollah, B., Patra, A. K., & Mohanty, S. R. (2016). Aquatic microphyllaAzolla: a perspective paradigm for sustainable agriculture, environment and global climate change. *Environ Sci Pollut Res*, 23: 4358–4369.
- MAAIF. (2010). *Agricultural Sector Development Strategy and Investment Plan, DSIP 2010/11-2014*. Kampala: MAAIF.
- Mahapatra, B., & Sharma, G. (1989). Integrated management of Sesbania, Azolla and urea nitrogen in lowland rice under a rice-wheat cropping system. *J Agric Sci* , 113:203–206.
- Malley, Z. J., Kayombo, B., Willcocks, T. J., & Mtakwa, P. W. (2004). Ngoro:an indigenous, sustainable and profitable soil, water and nutrient conservation system in Tanzania for sloping land. *Soil Till. Res.* 77, 47-58.

- Mandal, B., Vlek, P., & Mandal, L. N. (1999). Beneficial effects of blue-green algae and Azolla, excluding supplying nitrogen, on wetland rice fields: a review. *Biol Fertil Soils* , 28:329–342.
- Masser, M. P., & Jensen, J. W. (1991). *Calculating Area and Volume of Ponds and Tanks*. SRAC.
- Mati, B. (2015, Nov). *Water pans and ponds*. Retrieved from Jomo Kenyatta University of Agriculture and Technology: <http://www.jkuat.ac.ke/departments/warrec/wp-content/uploads/2015/09/WATER-PANS-AND-PONDS.pdf>
- McCartney, M., & Smakhtin, V. (2010). *Water storage in an era of climate change: addressing the challenge of increasing rainfall variability. Blue paper*. Colombo, Sri Lanka: International Water Management Institute (IWMI). 14p .
- McLaughlin , N., Hiba , A., G, W. J., & D, K. J. (2000). Comparison of energy inputs for inorganic fertilizer and manure based corn production. *Can Agric Eng* , 9-18.
- Mills, L. (2004). *Evaluation of the water harvesting schemes component of the EC funded programs, IFSP 1998 and 2000 in Tigray, Ethiopia. Working Paper 1- Water Harvesting Structures. Tigray, Ethiopia*. Tigray, Ethiopia.
- Molle, B., Tomas, S., Hendawi, M., & Granier, J. (2012). Evaporation and wind drift losses during sprinkler irrigation influenced by droplet size distribution. *Irrig. and Drain*, 61: 240-250.
- Mubiru, D. (2010). *CLIMATE CHANGE AND ADAPTATION OPTIONS*. Kampala: (NARO) National Agricultural Research Laboratories – Kawanda.
- Mugasha, C. (2014). *Uganda: Farmers Want To Turn To Irrigation As Drought Drags On*. Kampala: NEPAD Water centers of excellence.
- MWLE. (2007). *Report on State of the Environment*. Kampala: Ministry of Water Lands and Environment .
- Nabikolo, D. (2009). Household headship and climate change adaptation among smallholder farmers in Soroti district, Eastern Uganda. *MSc thesis Submitted to Makerere University Uganda*.
- Ngigi, S. N., Savenije, H. H., Rockstrom, J., & Gachene , K. C. (2005). Hydro-economic evaluation of rainwater harvesting and management technologies: farmers' investment options and risks in semi-arid Laikipia district of Kenya. *Phys. Chem. Earth* , 772-782.
- Okalebo, J., Gathua, K., & Woomer, P. (2002). *Laboratory methods of soil analysis: A working manual, second edition*. . Nairobi, Kenya.: TSBRCIAT and SACRED Africa.
- Ortiz-Marquez, J., Do Nascimento, M., Curatti, & Curatti, L. (2014). Metabolic engineering of ammonium release for nitrogen-fixing multispecies microbial cell-factories. *Metab Eng*, 23:154–164.
- Oweis, T., & Hachum, A. (2012). *SUPPLEMENTAL IRRIGATION A HIGHLY EFFICIENT WATER-USE PRACTICE*. Aleppo, Syria: ICARDA.
- Oweis, T., Hachum, T. A., & Bruggeman, A. (2004). *Indigenous Water-Harvesting Systems in West Asia and North Africa*. Aleppo, Syria: ICARDA.

- Pandey, P. K., Zaag, P. v., & Soupir, M. L. (2013). A New Model for Simulating Supplemental Irrigation and the Hydro-Economic Potential of a Rainwater Harvesting System in Humid Subtropical Climates. *Water Resources Management*, 3145–3164.
- Pandey, P., Panda, S., & Panigrahi, B. (2006). Sizing on-farm reservoirs for crop-fish integration in rainfed farming systems in Eastern India. *Biosyst Eng*, 93: 475–489.
- Pandey, P., Soupir, M., Singh, V., Panda, S., & Pandey, V. (2011). Modelling rainwater storage in distributed reservoir systems in humid subtropical and tropical savannah regions. *Water Resour Manage*, 25: 3091-3111. DOI 10.1007/s11269-011-9847-5.
- Panigrahi, B., Panda, S., & Mull, R. (2001). Simulation of water harvesting potential in Rainfed ricelands using water balance model. *Agricult Sys*, 69: 165-182.
- PANNAR. (2016, November 14). *PANNAR Together we farm for the future*. Retrieved from PANNAR: [http://www.pannar.com/blog/detail/manage\\_the\\_growth\\_stages\\_of\\_the\\_maize\\_plant](http://www.pannar.com/blog/detail/manage_the_growth_stages_of_the_maize_plant)
- Pingale, S. M., Khare, D., Sharma, H. C., & Mahesh, J. K. (2009). DESIGN OF WATER HARVESTING STRUCTUREBASED ON SUPPLY AND DEMAND OF WATER IN AHILLY WATERSHED. *Journal of Environmental Research And Development*, Vol. 3 : 645-653.
- Ramamohan Reddy, K. R., Venkateswara , B. R., & Sarala, C. (2014). *HYDROLOGY AND WATERSHED MANAGEMENT*. Telangana State: Allied Publishers.
- Rana, A., Kabi, S., Verma, S., Adak, A., Pal, M., Shivay, Y., . . . Nain, L. (2015). Prospecting plant growth promoting bacteria and cyanobacteria as options for enrichment of macro-and micronutrients in grains in rice–wheat cropping sequence. *Cogent Food Agric*.
- Rockstrom, J. (1997). *On-farm agrohydrological analysis of the Sahelian yield crisis: Rainfall partitioning, soli nutrients, and water use efficiency of pearl millet*. Stockholm.
- Rockström, J., & Barron, J. (2007). Water productivity in rainfed systems: overview of challenges and analysis of opportunities in water scarcity prone savannahs. *Irrig Sci*, 25: 299 – 311.
- Rockström, J., Barron, J., & Fox, P. (2003). Water productivity in rain-fed agriculture: Challenges and opportunities for smallholder farmers in drought-prone tropical agro- ecosystems in *Water Productivity in Agriculture: Limits and Opportunities for Improvements*. CABI, Oxon, Mass. , 145–162.
- Rockström, J., Falkenmark, M., Karlberg, L., Hoff, H., RosT, S., & Gerten, D. (2009). Future water availability for global food production: The potential of green water for increasing resilience to global change. *Water Resour Res*, 45: W00A12. doi:10.1029/ 2007WR006767.
- Shiksha. (2017). *Crop production and Management*. Retrieved from Shiksha: [http://www.ekshiksha.org.in/chapter/196/crop\\_production\\_and\\_management.html?lang=1](http://www.ekshiksha.org.in/chapter/196/crop_production_and_management.html?lang=1)
- Sholkamy, E. N., El-Komy, H. M., & Ali, H. M. (2015). Enhancement of soybean (*Glycine max L.*) growth by biofertilizers of *Nostoc muscorum* and *Nostoc rivulare*. *Pak J Bot*, 47: 1199–1204.
- SIBs. (2017, October 6). *Centre for Social Impact Bonds*. Retrieved from Cabinet Office: [https://data.gov.uk/sib\\_knowledge\\_box/](https://data.gov.uk/sib_knowledge_box/)

- Siegert, K. (1993). *Introduction to water harvesting: some basic principles for planning, design and monitoring: water harvesting for improved agricultural production. In: Proceedings of the FAO Expert Consultation, Cairo, Egypt.* Rome, Italy: FAO.
- Sivanappan, R. K. (2006). *Rain Water Harvesting, Conservation and Management Strategies for Urban and Rural Sectors.* Nagpur.
- Slingerland, M. A., & Stork, V. E. (2000). Determinants of the practice of Zai and mulching in north Burkina Faso. *J. Sustain. Agric.* 16, 53–76. *Sustain. Agric.* 16., 53-76.
- Spaan, W. (2003). Consuming the savings: water conservation in a vegetation barrier system at the Central Plateau in Burkina Faso. *Tropical Resources Management. Tropical Resources Management Papers, 42, 14.*
- Subedi, P., & Shrestha, J. (2015). Improving soil fertility through Azolla application in low land rice, a review. *Azarian Journal of Agriculture.*
- Sur, H., Bhardwaj, A., & Jindal, P. (1999). Some hydrological parameters for design and operation of small earthen dams in lower Shiwaliks of northern India. *Agric. Water Manage, 1479:111–121.*
- Tesfai, M., & Stroosnijder, L. (2001). *The Eritrean spate irrigation system.* . 48, 51-60: *Agric. Water Manage.* .
- TradingEconomics. (2017, Oct 20). *Trading Economics.* Retrieved from Trading economics Uganda: <https://tradingeconomics.com/uganda/inflation-cpi/forecast>
- UBOS/MAAIF. (2010). *UGANDA CENSUS OF AGRICULTURE 2008/2009 - CROP AREA AND PRODUCTION REPORT.* Kampala: Uganda Bureau of Statistics.
- UNDP. (2006). *Beyond scarcity: power, poverty and the global water crisis. Human Development Report.* New York: United Nations.
- UNWater/FAO. (2007). *Coping with water scarcity - Challenge of the twenty-first century.* UN Water.
- van der Zaag, P., & Gupta, J. (2008). Scale issues in the governance of water storage projects. *Water Resour Res 44:* , W10417, doi:10.1029/2007WR006364.
- Van Hove, C. (1989). Azolla and its multiple uses with emphasis on Africa. *FAO Rome, Italy, 61.*
- Van Hove, C., & Lejeune, A. (2002). APPLIED ASPECTS OF AZOLLA-ANABAENA SYMBIOSIS. *Cyanobacteria in Symbiosis. Springer Netherlands, 179-193.*
- Vanuytrecht, E., Raes, D., Steduto, P., Hsiao, T. C., Fereres, E., Heng, L. K., . . . Moreno, P. M. (2014). AquaCrop: FAO's crop water productivity and yield response model. *Environmental Modelling & Software, 62.* 351-360.
- Veluci, R., Neher, D., & Weicht, T. (2006). Veluci RM, NeNitrogen fixation and leaching of biological soil crust communities in mesic temperate soils. *Microb Ecol, 51:189–196.*
- Wagner, S. (2011). Biological nitrogen fixation. *Nat Educ Knowl, 2:14.*

WaterGardeningDirect. (2017, Nov 04). *How to Calculate the Pond liner size*. Retrieved from Water Gardening Direct: <http://www.watergardeningdirect.com/acatalog/How-To-Calculate-Your-Pond-Liner-Size.html>

Worldbank. (2000). *World Development Report 1999/2000*. Oxford Press.

Xie, J., Wu, X., Tang, J., Zhang, J., & X, C. (2010). Chemical fertilizer reduction and soil fertility maintenance in rice-fish coculture system. *Front Agric China* , 4:422–429.

Yohannes, O., & Yohannes, K. (2012). Turmoil in the Nile River Basin: Back to the Future? *Journal of Asian and African Studies*, 195-208.

## Appendix

Table 0.1 Net Present Values for the projected 17 years for different pond volumes

2023	2022	2021	2020	2019	2018	2017	Year	1000 m3 Pond
3,140,848	2,894,330	2,667,160	2,457,820	2,264,910	2,087,142	-	Cash Inflow	11,835,000
6	5	4	3	2	1	0	Time (Years)	0
1,772,927	1,797,151	1,821,706	1,846,596	1,871,827	1,897,402	-	DCF	11,835,000
3,136,336	2,890,171	2,663,327	2,454,288	2,261,656	2,084,144	-	Cash Inflow	9,720,000
1,770,380	1,794,569	1,819,088	1,843,943	1,869,137	1,894,676	-	DCF	9,720,000
2,669,270	2,459,764	2,266,702	2,088,794	1,924,848	1,773,771	-	Cash Inflow	7,655,000
1,506,733	1,527,320	1,548,188	1,569,342	1,590,784	1,612,519	-	DCF	7,655,000
1,850,212	1,704,993	1,571,172	1,447,854	1,334,215	1,229,495	-	Cash Inflow	4,040,000
1,044,397	1,058,666	1,073,131	1,087,794	1,102,657	1,117,722	-	DCF	4,040,000

2034	2033	2032	2031	2030	2029	2028	2027	2026	2025	2024
7,718,550	7,112,737	6,554,473	6,040,026	5,565,957	5,129,096	4,726,524	4,355,549	4,013,691	3,698,664	3,408,364
17	16	15	14	13	12	11	10	9	8	7
1,527,074	1,547,939	1,569,089	1,590,528	1,612,259	1,634,288	1,656,618	1,679,253	1,702,197	1,725,454	1,749,030
7,707,460	7,102,518	6,545,056	6,031,348	5,557,960	5,121,727	4,719,733	4,349,291	4,007,924	3,693,350	3,403,467
1,524,880	1,545,715	1,566,834	1,588,242	1,609,943	1,631,940	1,654,238	1,676,840	1,699,751	1,722,975	1,746,517
6,559,659	6,044,805	5,570,360	5,133,154	4,730,263	4,358,995	4,016,866	3,701,591	3,411,060	3,143,333	2,896,619
1,297,794	1,315,526	1,333,500	1,351,720	1,370,189	1,388,910	1,407,887	1,427,123	1,446,623	1,466,388	1,486,424
4,546,847	4,189,974	3,861,112	3,558,061	3,278,796	3,021,450	2,784,303	2,565,769	2,364,387	2,178,811	2,007,800
899,569	911,861	924,319	936,949	949,750	962,727	975,881	989,215	1,002,731	1,016,431	1,030,319





2034	2033	2032	2031	2030	2029	2028	2027	2026	2025	2024
17	16	15	14	13	12	11	10	9	8	7
12,821,579	12,153,156	11,519,579	10,919,032	10,349,793	9,810,231	9,298,797	8,814,025	8,354,526	7,918,982	7,506,144
2,536,681	2,644,881	2,757,696	2,875,322	2,997,966	3,125,842	3,259,172	3,398,188	3,543,135	3,694,264	3,851,839
1,813,906	1,719,342	1,629,708	1,544,747	1,464,215	2,757,701	1,315,527	1,246,945	1,181,939	1,120,321	1,061,916
358,872	374,179	390,139	406,780	424,131	878,689	461,084	480,751	501,257	522,638	544,931
646,049	612,368	580,444	550,184	521,501	494,314	468,544	9,087,329	420,965	399,018	378,217
127,817	133,269	138,954	144,881	151,060	157,504	164,222	3,503,559	178,530	186,145	194,085
1,123,131	1,064,579	1,009,079	956,473	906,610	859,346	814,546	772,081	731,831	693,678	657,515
222,205	231,683	241,566	251,869	262,613	273,814	285,493	297,671	310,368	323,606	337,409

<b>Total</b>			<b>66,662,25</b>		<b>11,148,64</b>		<b>11,751,28</b>		<b>7,929,407</b>
			<b>5</b>		<b>7</b>		<b>3</b>		